

To obtain current ISO Certifications,
Listings and other Approvals visit Anvil's
website at www.anvilintl.com



ANVIL®
INTERNATIONAL, INC.



Standard Products

PRICE SHEET GL-3-2006

EFFECTIVE: March 6, 2006
(Cancels Price Sheet of April 4, 2005)

**SUBJECT TO CHANGE WITHOUT NOTICE
GO TO WEB SITE FOR MOST CURRENT
LIST PRICE INFORMATION/CHANGES
OR CONTACT AN ANVIL REPRESENTATIVE**

www.anvilintl.com

UPC Numbers are available upon request.
Please contact your local ANVIL representative.

FREIGHT ALLOWANCE:

All prices are F.O.B. point of shipment. On shipments weighing 2,500 lbs. or more, rail freight or motor freight at the lowest published rates, is allowed to all continental U.S. rail points or all U.S. highway points listed in published tariffs (Alaska and Hawaii excluded). In no case will more than actual freight be allowed.

NOTE:

All orders are accepted on the basis of prices in effect at the time of shipment.

NOTICE:

To the prices and terms quoted, there will be added any manufacturers or sales tax payable on the transaction under any effective statute.

1. CONTROLLING PROVISIONS:

These terms and conditions shall control with respect to any purchase order or sale of Seller's products. No waiver, alteration or modification of these terms and conditions whether on Buyer's purchase order or otherwise shall be valid unless the waiver, alteration or modification is specifically accepted in writing and signed by an authorized representative of Seller.

2. DELIVERY:

Seller will make every effort to complete delivery of products as indicated on Seller's acceptance of an order, but Seller assumes no responsibility or liability, and will accept no backcharge, for loss or damage due to delay or inability to deliver caused by acts of God, war, labor difficulties, accident, delays of carriers, by contractors or suppliers, inability to obtain materials, shortages of fuel and energy, or any other causes of any kind whatever beyond the control of Seller. Seller may terminate any contract of sale of its products without liability of any nature, by written notice to Buyer, in the event that the delay in delivery or performance resulting from any of the aforesaid causes shall continue for a period of sixty (60) days. Under no circumstances shall Seller be liable for any special or consequential damages or for loss, damage, or expense (whether or not based on negligence) directly or indirectly arising from delays or failure to give notice of delay.

3. WARRANTY:

Seller warrants for one year from the date of shipment Seller's manufactured products to the extent that Seller will replace those having defects in material or workmanship when used for the purpose and in the manner which Seller recommends. If Seller examination shall disclose to its satisfaction that the products are defective, and an adjustment is required, the amount of such adjustment shall not exceed the net sales price of the defective products only and no allowance will be made for labor or expense of repairing or replacing defective products or workmanship of damage resulting from the same. Seller warrants the products which it sells of other manufacturers to the extent of the warranties of their respective makers. Where engineering design or fabrication work is supplied. Buyer's acceptance of Seller's design or of delivery of work shall relieve Seller of all further obligation, other than expressed in Seller's product warranty. THIS IS SELLER'S SOLE WARRANTY. SELLER MAKES NO OTHER WARRANTY OF ANY KIND, EXPRESSED OR IMPLIED AND ALL IMPLIED WARRANTIES OF MERCHANTABILITY AND FOR A PARTICULAR PURPOSE WHICH EXCEED SELLER'S AFORESAID OBLIGATION ARE HEREBY DISCLAIMED BY SELLER AND EXCLUDED FROM THIS WARRANTY. Seller neither assumes, nor authorizes any person to assume for it, any other obligation in connection with the sale of its engineering designs or products. This warranty shall not apply to any products or parts of products which (a) have been repaired or altered outside of Seller's factory, in any manner; (b) have been subjected to misuse, negligence or accidents; (c) have been used in a manner contrary to Seller's instructions or recommendations. Seller shall not be responsible for design errors due to inaccurate or incomplete information supplied by Buyer or its representatives.

4. SELLER'S LIABILITY:

Seller will not be liable for any loss, damage, cost of repairs, incidental or consequential damages of any kind, whether based upon warranty (except for the obligation accepted by Seller under "Warranty" above), contract or negligence, arising in connection with the design, manufacture, sale, use or repair of the products or of the engineering designs supplied to Buyer.

5. RETURNS:

Seller cannot accept return of any products unless its written permission has been first obtained, in which case same will be credited subject to the following (a) All material returned must, on its arrival at Seller's Plant, be found to be in first-class condition; if

not, cost of putting in saleable condition will be deducted from credit memoranda; (b) A handling charge deduction of twenty percent (20%) will be made from all credit memoranda issued for material returned; (c) Transportation charges, if not prepaid will be deducted from credit memoranda.

6. SHIPMENTS:

All products sent out will be carefully examined, counted and packed. The cost of any special packing or special handling caused by Buyer's requirements or requests shall be added to the amount of the order. No claim for shortages will be allowed unless made in writing within ten (10) days of receipt of a shipment.

Claims for products damaged or lost in transit should be made on the carrier, as Seller's responsibility ceases, and title passes, on delivery to the carrier.

7. SPECIAL PRODUCTS:

Orders covering special or nonstandard products are not subject to cancellation except on such terms as Seller may specify on application.

8. PRICES AND DESIGNS:

Prices and designs are subject to change without notice. All prices are F.O.B. Point of shipment, unless otherwise stated.

9. TAXES:

The amount of any sales, excise or other taxes, if any, applicable to the products covered by this order, shall be paid by Buyer unless Buyer provides Seller with an exemption certificate acceptable to the taxing authorities.

10. NUCLEAR PLANTS:

Where the products, engineering design or fabrication is for nuclear plant applications. Buyer agrees (a) to take all necessary steps to add Seller as an insured under the American Nuclear Insurers' (ANI) pool and under the Mutual Atomic Energy Reinsurance Pool (MAERP) for property damage and liability insurance and if necessary steps could have been taken, but are not taken, Buyer shall hold Seller harmless against all such losses which could have been thus covered (b) Buyer agrees to hold Seller harmless with respect to any personal injury (for death), property damage or other loss in nuclear incident which is caused directly or indirectly by defective design, material, workmanship furnished by Seller and which is covered by insurance maintained by Buyer (or which could be so covered but with respect to which Buyer has elected to self-insure), and further agrees to waive subrogation by its carriers of such insurance against Seller, and (c) as to nuclear hazards for which Buyer cannot obtain insurance coverage, the liability of Seller for any personal injury (or death), property damage or other loss directly caused by defective design, material, or workmanship furnished by Seller shall not exceed the value at the time of the loss occurrence.

11. MINIMUM INVOICE: \$25.00 plus transportation.

12. TERMS: Cash, net 30 days unless otherwise specified.

NOTE: All orders are accepted on the basis of prices in effect at the time of shipment.

NOTICE: The prices and terms quoted, there will be added any manufacturers or sales tax payable on the transaction under any effective statute.

FREIGHT ALLOWANCE: All prices are F.O.B. point of shipment. On shipments of 2,500 pounds or more, rail freight or motor freight at the lowest published rates is allowed to all continental U.S. rail points or all U.S. highway points listed in published tariffs (Alaska and Hawaii excluded). In no case will more than actual freight be allowed.

Your order must specify gasket grade

Standard Gaskets

Grade	Temperature Range	Compound	Color Code	*General Service Application
E	-40°F to +230°F	EPDM	Green	Water, dilute acids, alkalis, salts and many chemical services not involving hydrocarbons, oils or gases. Excellent oxidation resistance. NOT FOR USE WITH HYDROCARBONS.
T	-20°F to +180°F	Nitrile (Buna-N)	Orange	Petroleum products, vegetable oils, mineral oils and air contaminated with petroleum oils. NOT FOR USE IN HOT WATER SERVICES.

Special Gaskets

Grade	Temperature Range	Compound	Color Code	*General Service Application
O	-20°F to +300°F	Fluoro Elastomer	Blue	High temperature resistance to oxidizing acids, petroleum oils, hydraulic fluids, halogenated hydrocarbons, and lubricants.
L	-40°F to +350°F	Silicone	Red Gasket	Dry, hot air and some high temperature chemical services.
E (Type A)	-40°F to +150°F		Violet	Wet and Dry (oil free air) pipe fire protection sprinkler systems. For dry pipe systems, Gruvlok Xtreme™ Lubricant is required.

*Contact Anvil for specific service recommendations. **Specify gasket grade when ordering.**

Use Gruvlok lubricant on gaskets. Check gasket color code to be certain it is recommended for the service intended. Additional gasket compounds and configurations are available - contact Anvil.

Lubricants

Standard Lubricant	Price
4 ½ oz. Tube	\$20.03/tube
Carton (w/12 Packs, 144 Tubes)	\$2,378.46/carton
1 Quart Can	\$102.82/can
5 Gallon Pail	\$868.93/pail
Quick Dry Lubricant	
1 Pint Can	\$78.37
1 Quart Can	\$110.24
1 Gallon Pail	\$186.91
Xtreme Lubricant (Silicone)	
10 oz. Tube (1 each)	\$50.94
2.2 lb. Tub (Gruvlok Lubricant)	\$293.62

Standard Lubricant Usage Guide

Size of Gasket	Number of Gaskets	
	Per Tube	Per Quart
2"	55	400
3"	45	300
4"	25	200
6"	20	130
8"	15	100
10"	10	85
12"	9	60
14"	7	50
16"	6	40
18"	5	35
20"	4	30
24"	3	20

Xtreme Lubricant Usage Guide

Size of Gasket	Number of Gaskets
	Per Quart
2"	1,200
3"	900
4"	600
6"	390
8"	300
10"	255
12"	180
14"	150
16"	120
18"	105
20"	90
24"	60

Terms and Conditions	2	Silent Check Valve Fig. 400G	24
Gasket Selection	3	Suction Diffuser Fig. 7250	25
Standard Gaskets	3	SF21-GG Grooved x Grooved Connectors	25
Special Gaskets	3	SF21-GF Grooved x Flange Connectors	25
Lubricants	3	SF21-FF Flange x Flange Connectors	25
Grooved-End Couplings	5-10	Gruvlok Air Vent GAV-15 & GAV-30	26
Standard Coupling Fig. 7001	5	Grooved-End "WYE" Strainer Fig. 768G	26
Standard Coupling Fig. 7011	5	Grooved-End Strainer Fig. 7260	26
Lightweight Flexible Coupling Fig. 7000	6	Fig. FTV-S (Straight) or Fig. FTV-A (Angle Body) ...	26
Hingelok Coupling Fig. 7003	6	Clamp-T® Grooved Outlet Fig. 7046	27
Rigidlok™ Rigid Coupling Fig. 7401	7	Clamp-T® Female Threaded Outlet Fig. 7045	27
Reducing Coupling Fig. 7010	7	Clamp-T® Cross Fig. 7047, Fig. 7048 and Fig. 7049 ...	28
Rigidlite® 300 PSI Coupling Fig. 7400	7	Adapter Flanges Fig. 7084 (150 lb.) & Fig. 7085 (300 lb.)	29
Outlet Couplings Fig. i7042F, i7042M and i7042G ...	8	Spare Parts	29-31
Flange Adapter for HDPE Pipe Fig. 7312	9	Flange Parts for Fig. 7012 & 7013 Gruvlok Flanges ..	29
HDPE Transition Coupling Fig. 7307	9	Flange Gaskets for Fig. 7012 & 7013 Gruvlok Flanges	30
HDPE Coupling Fig. 7305	9	Standard Gaskets for Fig. 7005 & 7305 Couplings ...	30
HPR Coupling Fig. 7004 HPR	9	Plated Trackhead Bolts and Nuts	30
End Guard Coupling Fig. 7004 EG	9	Standard Gaskets	30
Gruvlok Flange Fig. 7012	10	Gaskets for Fig. 7004 EG	30
Gruvlok 300# Flange Fig. 7013	10	Reducing Coupling Fig. 7010 (Gasket Only)	30
Fittings for Grooved-End Pipe	11-20	Clamp-T® Grooved Outlet Fig. 7046 (Gasket Only) ...	31
90° Elbows Fig. 7050	11	Clamp-T® Female Threaded Outlet	
22½° Elbows Fig. 7052	11	Fig. 7045 (Gasket Only)	31
45° Elbows Fig. 7051	11	Plain-End	31
11¼° Elbows Fig. 7053	11	Plain-End Coupling Roughneck™ Coupling Fig. 7005 ..	31
Tees Fig. 7060	12	Gruvlok Advanced Copper System	32-34
Tees with Threaded Branch Fig. 7063	12	Rigidlite® 300 PSI Coupling Fig. 7400	32
Reducing Tee Fig. 7061	13	Gruvlok Flange Fig. 7012	32
Reducing Tee with Threaded Branch Fig. 7064	14	90° Elbows Fig. 7550	32
Concentric Reducer Fig. 7072	15	45° Elbows Fig. 7551	32
Reducer Threaded Small End Fig. 7076	16	Tee Fig. 7560	32
Cap Fig. 7074	16	Copper Reducing Tee Fig. 7561A	33
Hose Nipple Fig. 7086	16	Copper Reducing Tee Fig. 7564A (Gr. x Gr. x Cup) ..	33
Eccentric Reducer Fig. 7073 & Fig. 7097	17	Concentric Reducers Fig. 7572 (Gr. x Gr.)	33
90° Long Radius Elbows Fig. 7050LR (1½"D)	18	Cap Fig. 7574	33
Reducing Base Support Elbows		Reducing Adapters Fig. 7575 (Gr. x Cup)	34
Fig. 7050RF Grooved x Flanged (GxF)	18	Transition Fitting, Fig. 7582 (Cup x Gr.)	34
45° Long Radius Elbows Fig. 7051 LR (1½"D)	18	DI-LOK® DI-Electric Nipple Fig. 7088 (Gr. x Th.) ...	34
Female Thread Adapter Fig. 7087	18	DI-LOK® DI-Electric Nipple Fig. 7089 (Gr. x Gr.) ...	34
Bullhead Plug Fig. 7075	19	DI-LOK® DI-Electric Nipple Fig. 7090 (Th. x Th.) ...	35
Lateral Fig. 7069	19	Bronze Grooved-End Ball Valve Fig. 7500B	35
Tee WYE Fig. 7066	19	Roll Groovers	36
Steel Cross Fig. 7068 and True Y Fig. 7071	20	Model 1007/3007 Roll Groover	36
Reducing Lateral – Fig. 7070	20	Model 3006 (Steel Roll Groover) –	
Valves and Accessories	21-29	For Ridgid® 300 Power Drive	36
Grooved-End Butterfly Valve Series 7700	21	Model 3006C (Copper Roll Groover) –	
Gruvlok Butterfly Valves Fig. 8000GR	22	For Ridgid® 300 Power Drive	36
Gruvlok Ball Valves Fig. 7500	22	Expansion Joints for Grooved-End Pipe	37
Bronze Grooved-End Ball Valve Fig. 7500B	23	Gruvlok Fig. 7240 Expansion Joint	37
Grooved End Butterfly Valve Series 7600	23	Numerical Index	38
Gruvlok Circuit Balancing Valves		Cross Reference	39
Sweat Four Turn Fig. GBV-S	23		
Threaded Four Turn Fig. GBV-T	23		
Grooved End Straight GBV-G & End Angle Fig. GBV-A	24		
End Check Valve Fig. 7800	24		

Standard Coupling Fig. 7001

For listing/approval details contact your Gruvlok Representative.

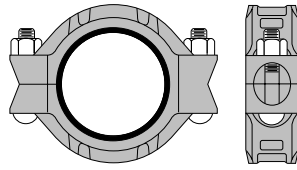

Sizes 1"-14"

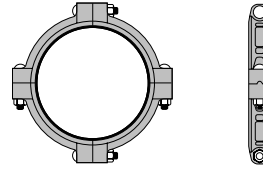

Sizes 16"-24"

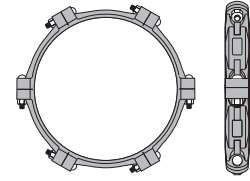

Sizes 28" and 30"

Nominal Pipe Size (Inches)	Pipe Outside Diameter (Inches)	Aprx. Weight Each (Lbs.)	Coupling Complete with "E" or "T" Gasket (Price Each)		Coupling Complete with Flush Gap™ "E" or "T" Gasket (Price Each)		Spare Parts Plated Bolt & Nut	
			Painted	Galvanized	Painted	Galvanized	Qty. No.	Size (Inches)
1	1.315	1.3	\$18.49	\$23.70	\$29.66	\$34.87	2	3/8 x 2 1/4
1 1/4	1.660	1.4	\$24.52	\$31.49	\$36.62	\$43.52	2	3/8 x 2 1/4
1 1/2	1.900	1.5	\$26.85	\$33.83	\$38.38	\$45.49	2	3/8 x 2 1/4
2	2.375	3.1	\$28.40	\$36.47	\$40.07	\$48.15	2	1/2 x 3
2 1/2	2.875	3.7	\$33.83	\$44.76	\$49.38	\$60.10	2	1/2 x 3
3	3.500	4.3	\$37.49	\$49.91	\$51.07	\$63.33	2	1/2 x 3
3 1/2	4.000	5.1	\$54.61	\$69.43	\$73.83	\$88.65	2	5/8 x 3 1/2
4	4.500	6.8	\$54.61	\$73.61	\$74.19	\$93.12	2	5/8 x 3 1/2
5	5.563	9.6	\$83.60	\$114.41	\$131.37	\$162.41	2	3/4 x 4 1/2
6	6.625	11.8	\$98.78	\$135.34	\$145.45	\$182.01	2	3/4 x 4 1/2
8	8.625	21.7	\$160.94	\$228.82	\$197.50	\$257.67	2	7/8 x 5 1/2
10	10.750	27.0	\$267.36	\$364.81	\$317.25	\$406.21	2	7/8 x 5 1/2
12	12.750	35.0	\$304.35	\$414.65	\$372.89	\$467.11	2	7/8 x 6
14	14.000	37.0	\$369.66	\$485.61	\$412.81	\$520.47	4	7/8 x 5 1/2
16	16.000	50.0	\$484.73	\$625.87	\$544.69	\$685.74	4	1 x 4
18	18.000	72.0	\$567.81	\$749.22	\$640.09	\$821.66	4	1 x 4
20	20.000	82.0	\$893.13	\$1,144.20	\$1,004.48	\$1,255.52	4	1 1/8 x 4 1/2
24	24.000	90.0	\$979.44	\$1,251.43	\$1,130.62	\$1,402.75	4	1 1/8 x 4 1/2
28	28.875	105.0	\$874.69	\$1,469.02	POA	POA	6	1 x 5 1/2
30	31.000	137.0	\$1,096.57	\$1,689.83	POA	POA	6	1 x 5 1/2

All bolts are oval-neck track head design to ASTM A-183, with heavy hex nuts to ASTM A-563, and are zinc plated to ASTM B-633. Number of bolts equals housing segments. Weights are approximate and subject to change. Grade "O" or "L" gaskets are available. Contact your Anvil representative for more details.

Standard Coupling Fig. 7011

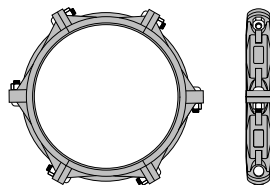

Nominal Pipe Size (Inches)	Pipe Outside Diameter (Inches)	Aprx. Weight Each (Lbs.)	Coupling Complete with "E" EPDM Gasket (Price Each)		Spare Parts Plated Bolt & Nut	
			Painted		Qty. No.	Size (Inches)
30 O.D.	30.000	200	\$1,988.97		6	1 1/4 x 4 3/8

Working pressure and end load values are for standard wall pipe.

Lightweight Flexible Coupling Fig. 7000



For listing/approval details contact your Gruvlok Representative.

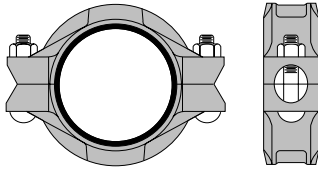

Nominal Pipe Size (Inches)	Pipe Outside Diameter (Inches)	Aprx. Weight Each (Lbs.)	Coupling Complete with "E" or "T" Gasket (Price Each)		Coupling Complete with Flush Gap™ "E" or "T" Gasket (Price Each)		Spare Parts Plated Bolt & Nut Size (Inches)
			Painted	Galvanized	Painted	Galvanized	
1	1.315	1.3	\$18.64	\$22.52	\$30.45	\$34.34	3/8 x 2 1/4
1 1/4	1.660	1.4	\$19.22	\$23.85	\$31.85	\$36.55	3/8 x 2 1/4
1 1/2	1.900	1.5	\$23.40	\$28.19	\$35.38	\$40.22	3/8 x 2 1/4
2	2.375	3.1	\$23.93	\$29.07	\$36.32	\$41.25	3/8 x 2 1/4
2 1/2	2.875	2.3	\$27.82	\$33.54	\$43.16	\$48.94	3/8 x 2 1/4
3	3.500	2.9	\$32.22	\$39.05	\$46.31	\$53.12	1/2 x 2 3/4
3 1/2	4.000	3.1	\$45.64	\$55.84	\$64.96	\$75.00	1/2 x 3
4	4.500	4.6	\$45.64	\$56.73	\$66.05	\$77.13	1/2 x 3
5	5.563	6.1	\$65.75	\$81.90	\$113.69	\$129.75	5/8 x 3 1/2
6	6.625	8.1	\$79.27	\$98.49	\$125.79	\$145.24	5/8 x 3 1/2
8	8.625	14.2	\$124.47	\$158.07	\$162.92	\$196.61	3/4 x 4 1/2

All bolts are oval-neck track head design to ASTM A-183, with heavy hex nuts to ASTM A-563, and are zinc plated to ASTM B-633. Number of bolts equals housing segments. Weights are approximate and subject to change. Grade "O" or "L" gaskets are available. Contact your Anvil representative for more details.

Hingelok Coupling Fig. 7003

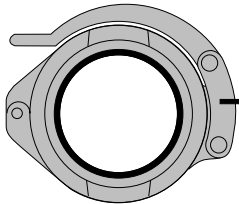

Nominal Pipe Size (Inches)	Pipe Outside Diameter (Inches)	Aprx. Weight Each (Lbs.)	Coupling Complete with "E" or "T" Gasket (Price Each)		Coupling Complete with Flush Gap™ "E" or "T" Gasket (Price Each)	
			Painted	Galvanized	Painted	Galvanized
1 1/2	1.900	1.7	\$39.41	\$45.58	\$50.49	\$56.65
2	2.375	2.2	\$39.92	\$46.38	\$51.37	\$57.91
2 1/2	2.875	3.2	\$51.96	\$61.57	\$66.35	\$75.82
3	3.500	3.6	\$62.81	\$74.27	\$76.03	\$88.15
4	4.500	5.1	\$81.02	\$99.29	\$99.95	\$118.52
5	5.563	9.5	\$160.73	\$194.18	\$205.35	\$238.81
6	6.625	11.2	\$174.38	\$209.67	\$217.96	\$253.41
8	8.625	18.1	\$268.09	\$319.82	\$303.76	\$356.15

Contact Anvil for specific service recommendations. Specify gasket grade when ordering. Use Gruvlok lubricant on gaskets. Check gasket color code to be certain it is recommended for the service intended.



Grooved-End Couplings

Fittings

Valves and Accessories

Spare Parts

Plain-End

Copper Method

Tools

Rigidlok™ Rigid Coupling Fig. 7401

For listing/approval details contact your Gruvlok Representative.

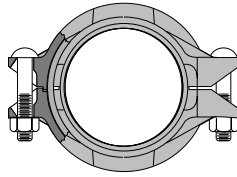

Sizes 1 1/2"-12"

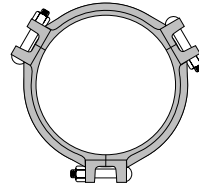
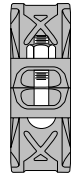

Sizes 14"-18"

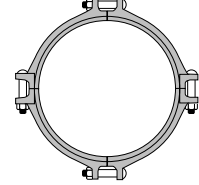

Sizes 20"-24"

Nominal Pipe Size (Inches)	Pipe Outside Diameter (Inches)	Aprx. Weight Each (Lbs.)	Coupling Complete with "E" or "T" Gasket (Price Each)		Coupling Complete with Flush Gap™ "E" or "T" Gasket (Price Each)		Spare Parts Plated Bolt & Nut	
			Painted	Galvanized	Painted	Galvanized	Qty. No.	Size (Inches)
1 1/2	1.900	1.8	\$25.69	\$30.82	\$37.05	\$42.20	2	3/8 x 2 1/4
2	2.375	2.4	\$26.34	\$32.22	\$38.01	\$43.96	2	3/8 x 2 1/2
2 1/2	2.875	2.9	\$30.38	\$37.43	\$46.46	\$52.24	2	3/8 x 2 3/4
3	3.500	3.6	\$35.38	\$43.96	\$49.03	\$57.54	2	1/2 x 3
4	4.500	5.0	\$50.20	\$62.30	\$69.80	\$81.90	2	1/2 x 3
5	5.563	6.9	\$65.10	\$81.09	\$110.60	\$186.70	2	5/8 x 3 1/2
6	6.625	7.9	\$87.05	\$107.52	\$131.22	\$152.58	2	5/8 x 3 1/2
8	8.625	15.9	\$136.94	\$170.11	\$173.35	\$206.52	2	3/4 x 4 1/2
10	10.750	25.6	\$245.27	\$312.05	\$295.17	\$357.54	2	1 x 6
12	12.750	30.5	\$274.33	\$336.05	\$336.05	\$493.98	2	7/8 x 6
14	14.000	36.1	\$358.51	\$437.47	\$401.65	\$480.62	2	7/8 x 5 1/2
16	16.000	40.8	\$467.41	\$567.44	\$527.37	\$627.55	3	7/8 x 5 1/2
18	18.000	51.6	\$540.36	\$665.85	\$615.58	\$738.07	4	1 x 4
20	20.000	68.3	\$643.33	\$799.06	\$754.73	\$911.27	4	1 x 4
24	24.000	89.3	\$947.44	\$1,141.49	\$1,098.62	\$1,292.60	4	1 x 4

All bolts are oval-neck track head design to ASTM A-183, with heavy hex nuts to ASTM A-563, and are zinc plated to ASTM B-633. Number of bolts equals housing segments. Weights are approximate and subject to change. Contact Anvil for specific service recommendations. **Specify gasket grade when ordering.** Use Gruvlok lubricant on gaskets. Check gasket color code to be certain it is recommended for the service intended.

Rigidlite® 300 PSI Coupling Fig. 7400

For listing/approval details contact your Gruvlok Representative.

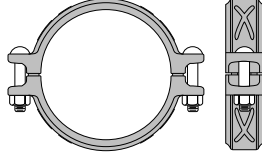

Plated Bolt & Nut Size (Inches)

Nominal Pipe Size (Inches)	Pipe Outside Diameter (Inches)	Aprx. Weight Each (Lbs.)	Coupling Complete w/"E" or "T" Gasket (Price Each)		Plated Bolt & Nut Size (Inches)
			Painted	Galv.	
1	1.315	1.2	\$17.77	\$20.48	3/8 x 2 1/4
1 1/4	1.660	1.3	\$18.35	\$22.89	3/8 x 2 1/4
1 1/2	1.900	1.4	\$20.26	\$27.15	3/8 x 2 1/4
2	2.375	1.6	\$22.52	\$23.78	3/8 x 2 1/4
2 1/2	2.875	1.9	\$25.54	\$27.67	3/8 x 2 1/4
3	3.500	2.1	\$29.36	\$32.29	3/8 x 2 3/4
4	4.500	3.1	\$41.54	\$45.58	3/8 x 2 3/4
5	5.563	4.6	\$60.99	\$66.05	1/2 x 3
6	6.625	5.5	\$74.56	\$79.85	1/2 x 3
8	8.625	8.4	\$117.05	\$124.62	1/2 x 3

All bolts are oval-neck track head design to ASTM A-183, with heavy hex nuts to ASTM A-563, and are zinc plated to ASTM B-633. Two bolts per coupling. Weights are approximate and subject to change. Contact Anvil for specific service recommendations. **Specify gasket grade when ordering.** Use Gruvlok lubricant on gaskets. Check gasket color code to be certain it is recommended for the service intended.

Reducing Coupling Fig. 7010

For listing/approval details contact your Gruvlok Representative.

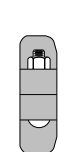
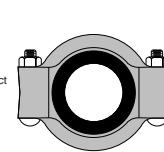
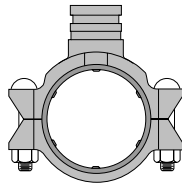

Fig. 7010 Coupling with Gasket

Nominal Pipe Size (Inches)	Aprx. Weight Each (Lbs.)	Coupling Complete w/"E" or "T" Gasket (Price Each)		Plated Bolt & Nut Size (Inches)
		Painted	Galv.	
2 x 1 1/2	2.0	\$40.50	\$46.61	1/2 x 2 3/4
2 1/2 x 2	3.5	\$52.91	\$63.48	1/2 x 2 3/4
3 x 2	4.4	\$60.55	\$73.25	1/2 x 2 3/4
3 x 2 1/2	4.1	\$51.96	\$63.48	1/2 x 2 3/4
4 x 2	8.9	\$96.50	\$115.97	5/8 x 3 1/2
4 x 2 1/2	7.9	\$86.08	\$108.48	5/8 x 3 1/2
4 x 3	6.7	\$80.79	\$99.73	5/8 x 3 1/2
5 x 4	11.4	\$108.91	\$136.65	3/4 x 4 1/2
6 x 4	13.4	\$165.05	\$198.22	3/4 x 4 1/2
6 x 5	13.5	\$144.43	\$178.56	3/4 x 4 1/2
8 x 6	17.7	\$247.77	\$298.47	3/4 x 4 1/2

All bolts are oval-neck track head design to ASTM A-183, with heavy hex nuts to ASTM A-563, and are zinc plated to ASTM B-633. Weights are approximate and subject to change.

Outlet Coupling Fig. i7042F, i7042M and i7042G



Grooved Outlet i7042G

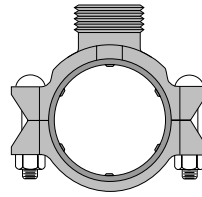

Male IPS Outlet i7042M

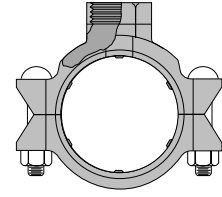

Female IPS Outlet i7042F

Nominal Pipe Size Run (Inches)	Branch (Inches)	i7042G & i7042M			i7042F		
		Aprx. Weight Each (Lbs.)	Grooved & Male Threaded Branch with "E" or "T" Gasket		Aprx. Weight Each (Lbs.)	Female Threaded Branch with "E" or "T" Gasket	
			Painted	Galvanized		Painted	Galvanized
1 1/2	x 1/2	-	-	-	2.6	\$51.66	\$58.20
	x 3/4	-	-	-	2.6	\$51.66	\$58.20
	x 1	-	-	-	2.6	\$51.66	\$58.20
2	x 1/2	-	-	-	3.3	\$53.06	\$62.74
	x 3/4	-	-	-	3.3	\$53.06	\$62.74
	x 1	3.3	\$58.27	\$68.99	3.3	\$53.06	\$62.74
2 1/2	x 1/2	-	-	-	4.8	\$82.18	\$96.80
	x 3/4	-	-	-	4.8	\$82.18	\$96.80
	x 1	-	-	-	4.8	\$82.18	\$96.80
	x 1 1/4	-	-	-	5.5	\$93.12	\$112.43
3	x 3/4	-	-	-	7.9	\$79.34	\$92.03
	x 1	7.9	\$120.95	\$131.66	7.9	\$79.34	\$92.03
	x 1 1/2	8.6	\$120.95	\$131.66	-	-	-
4	x 3/4	-	-	-	9.9	\$116.99	\$138.56
	x 1	9.9	\$116.99	\$138.56	-	-	-
	x 1 1/2	-	-	-	11.0	\$166.60	\$201.75
	x 2	11.0	\$166.60	\$201.75	-	-	-
6	x 1	-	-	-	18.0	\$235.94	\$291.73
	x 1 1/2	-	-	-	18.0	\$235.94	\$291.73
	x 2	18.0	\$235.94	\$292.01	-	-	-

Contact Anvil for specific service recommendations. **Specify gasket grade when ordering.**
 Use Gruvlok lubricant on gaskets. Check gasket color code to be certain it is recommended for the service intended.

Grooved-End Couplings
 Fittings
 Valves and Accessories
 Spare Parts
 Plain-End
 Copper Method
 Tools

HPR Coupling Fig. 7004 HPR (with Standard Gasket)

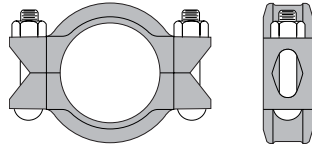

Nominal Pipe Size (Inches)	Pipe Outside Diameter (Inches)	Aprx. Weight Each (Lbs.)	Coupling Complete w/ "E" or "T" Gasket (Price Each)		Plated Bolt & Nut Size (Inches)
			Painted	Galv.	
2	2.375	3.9	\$35.38	\$45.58	5/8 x 2 3/4
2 1/2	2.875	4.6	\$40.22	\$52.24	5/8 x 3 1/2
3	3.500	5.2	\$44.76	\$58.20	5/8 x 3 1/2
4	4.500	8.6	\$66.05	\$89.75	3/4 x 4 1/2
5	5.563	14.0	\$135.32	POA	7/8 x 5 1/2
6	6.625	15.5	\$120.21	\$165.05	7/8 x 5 1/2
8	8.625	25.6	\$193.31	\$264.64	1 x 5 1/2
10	10.750	32.3	\$358.07	\$466.38	1 x 6 1/2
12	12.750	43.9	\$522.67	\$665.63	1 x 6 1/2

All bolts are oval-neck track head design to ASTM A-183, with heavy hex nuts to ASTM A-563, and are zinc plated to ASTM B-633. Weights are approximate and subject to change. For pricing on spare parts see page 30.

End Guard Coupling Fig. 7004 EG (with End Guard Gasket)

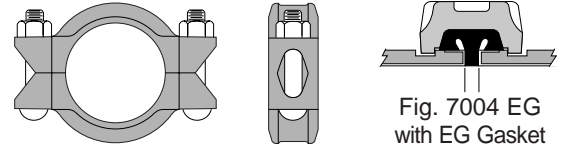

Fig. 7004 EG with EG Gasket

Nominal Pipe Size (Inches)	Pipe Outside Diameter (Inches)	Aprx. Weight Each (Lbs.)	Coupling Complete with EG Gasket (Price Each)		Plated Bolt & Nut* Size (Inches)
			Painted	Galv.	
2	2.375	4.1	\$46.17	\$56.57	5/8 x 2 3/4
2 1/2	2.875	5.1	\$53.79	\$67.22	5/8 x 3 1/2
3	3.500	5.5	\$60.63	\$75.96	5/8 x 3 1/2
4	4.500	9.0	\$86.08	\$110.67	3/4 x 4 1/2
6	6.625	15.5	\$149.49	\$246.87	7/8 x 5 1/2
8	8.625	26.5	\$231.25	\$298.11	1 x 5 1/2
10	10.750	32.3	\$435.42	\$547.91	1 x 6 1/2
12	12.750	43.9	\$549.47	\$692.79	1 x 6 1/2

*All bolts are oval-neck track head design to ASTM A-183, with heavy hex nuts to ASTM A-563, and are zinc plated to ASTM B-633. Weights are approximate and subject to change. For use with cement-lined and plastic coated pipe where protection at pipe ends is desired. When "End Guard Couplings" (Fig. 7004 EG) are used.

Couplings for HDPE Pipe

HDPE Coupling Fig. 7305

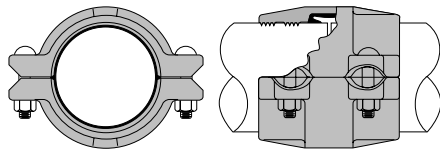

Nominal Pipe Size (Inches)	Pipe Outside Diameter (Inches)	Aprx. Weight Each (Lbs.)	Complete "E" or "T" Gasket Price Each
2	2.375	4.5	\$197.05
3	3.500	8.5	\$235.64
4	4.500	12.0	\$258.99
6	6.625	18.0	\$308.67
8	8.625	30.0	\$422.79
10	10.750	43.0	\$486.21
12	12.750	58.0	\$560.39

Weights are approximate and subject to change. UPC numbers and commodity identification numbers are available upon request. *Contact your Anvil Representative for galvanized pricing.

HDPE Transition Coupling Fig. 7307

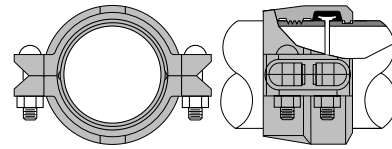

Nominal Pipe Size (Inches)	Pipe Outside Diameter (Inches)	Aprx. Weight Each (Lbs.)	Coupling "E" or "T" Gasket (Price Each)	Bolt Size
2	2.375	4.5	\$212.16	1/2 x 2 3/8
3	3.500	6.0	\$248.72	1/2 x 3
4	4.500	8.5	\$290.91	1/2 x 3
6	6.625	12.5	\$399.97	5/8 x 3 1/2
8	8.625	20.5	\$460.73	5/8 x 3 1/2
10	10.750	34.5	\$636.27	7/8 x 5 1/2
12	12.750	42.5	\$727.87	7/8 x 5 1/2

Weights are approximate and subject to change. UPC numbers and commodity identification numbers are available upon request. *Contact your Anvil Representative for galvanized pricing.

Flange Adapter for HDPE Pipe, Fig. 7312 HDPE Flange Complete

Nominal Pipe Size (Inches)	Aprx. Weight Each (Lbs.)	HDPE Flange Complete with "E" or "T" Gasket Price Each
4	15	\$301.99
6	22	\$424.26
8	28	\$498.61

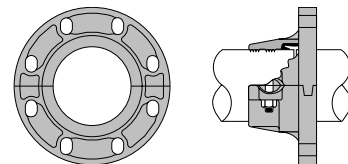

HDPE Flange has ductile iron housing. Not supplied with flange bolts, nuts or gasket. *Contact your Anvil Representative for galvanized pricing.

Gruvlok Flange Fig. 7012

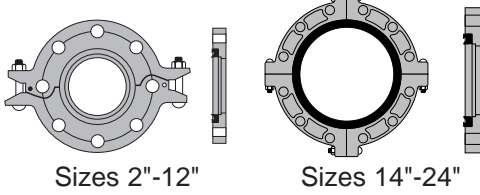

Sizes 2"-12"

Sizes 14"-24"

Nominal Pipe Size (Inches)	Pipe Outside Diameter (Inches)	Aprx. Weight Each (Lbs.)	Coupling Complete w/"E" or "T" Gasket (Price Each)	
			Painted	Galv.
Hinged				
2*	2.375	4.6	\$117.20	\$134.76
2½*	2.875	6.2	\$145.83	\$170.78
3*	3.500	6.6	\$157.34	\$185.75
4*	4.500	9.3	\$211.14	\$248.79
5*	5.563	10.2	\$245.06	\$289.01
6*	6.625	12.0	\$267.43	\$316.73
8*	8.625	15.6	\$301.99	\$368.63
10*	10.750	18.2	\$478.78	\$578.59
12*	12.750	29.9	\$626.60	\$765.81

Four Piece

14*	14.000	52.5	\$1,438.41	\$1,682.80
16*	16.000	67.0	\$1,669.15	\$1,967.62
18*	18.000	82.5	\$2,054.65	\$2,490.89
20*	20.000	106.5	\$2,472.97	\$3,009.29
24*	24.000	138.5	\$3,164.44	\$3,881.59

The Gruvlok Flange bolt hole pattern conforms to Class 150 steel and Class 125 cast iron flanges utilizing standard flange bolts.

*Available with pn 10/16 bolt hole patterns.

Flange Sealing Rings are recommended for use between wafer/lug type valves and Gruvlok Flanges.

For applications with wafer valves a latch bolt is recommended on both sides of the flange. (request extra latch bolt) Use: 3/8 x 2½ for 2"-6", ½ x 3½ for 8"-12" sizes.

Gruvlok 300# Flange Fig. 7013

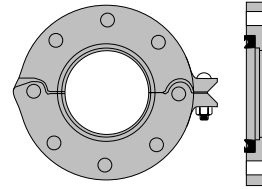

Nominal Pipe Size (Inches)	Pipe Outside Diameter (Inches)	Aprx. Weight Each (Lbs.)	Coupling Complete w/ "E" or "T" Gasket (Price Each)	
			Painted	Galv.
2	2.375	5.0	\$146.99	\$164.61
2½	2.875	6.9	\$170.40	\$193.96
3	3.500	9.4	\$233.17	\$263.40
4	4.500	14.4	\$311.02	\$358.66
5	5.563	18.3	\$353.57	\$406.93
6	6.625	24.9	\$411.57	\$480.04
8	8.625	35.4	\$472.47	\$566.48
10	10.750	54.0	\$752.96	\$890.50
12	12.750	74.8	\$804.04	\$986.56

The Gruvlok 300# Flange bolt hole pattern conforms to Class 300 steel, utilizing standard flange bolts.

**Flange Sealing rings are recommended for use between wafer/lug type valves and Gruvlok flanges.

Flange Bolts, Nuts and Gaskets not provided.

90° Elbows Fig. 7050



For listing/approval details contact your Gruvlok Representative.

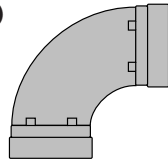

Nominal Pipe Size (Inches)	Aprx. Weight Each (Lbs.)	Price Each	
		Painted	Galvanized
1	0.6	\$34.87	\$44.04
1¼	1.0	\$34.87	\$44.04
1½	1.2	\$34.87	\$44.04
2	1.7	\$34.87	\$44.04
2½	2.6	\$34.87	\$44.04
3	4.0	\$61.94	\$73.68
3½	5.5	\$72.08	\$90.41
4	7.7	\$67.44	\$89.75
5	11.1	\$162.69	\$200.28
6	16.5	\$191.10	\$241.75
8	30.6	\$399.89	\$502.13
10	53.5	\$727.94	\$896.87
12	82.0	\$1,166.66	\$1,431.30
14*	169.0	\$2,096.35	\$2,587.31
16*	222.0	\$2,723.08	\$3,349.01
18*	280.0	\$3,454.61	\$4,096.03
20*	344.0	\$4,556.04	\$5,375.93
24*	490.0	\$6,597.84	\$7,810.53

45° Elbows Fig. 7051



For listing/approval details contact your Gruvlok Representative.

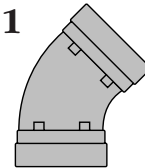

Nominal Pipe Size (Inches)	Aprx. Weight Each (Lbs.)	Price Each	
		Painted	Galvanized
1	0.5	\$34.87	\$41.31
1¼	0.7	\$34.87	\$41.31
1½	0.9	\$34.87	\$41.31
2	1.5	\$34.87	\$41.31
2½	1.9	\$34.87	\$41.31
3	3.3	\$61.94	\$69.43
3½	4.3	\$72.08	\$85.72
4	5.4	\$67.44	\$83.88
5	9.0	\$162.69	\$192.05
6	11.2	\$191.10	\$229.86
8	19.8	\$399.89	\$478.05
10	34.3	\$727.94	\$755.45
12	50.0	\$1,166.66	\$1,293.39
14*	92.0	\$1,569.57	\$1,911.48
16*	117.0	\$1,766.91	\$2,085.63
18*	146.0	\$2,071.02	\$2,413.03
20*	179.0	\$2,721.02	\$3,180.52
24*	255.0	\$4,179.03	\$4,843.20

Gruvlok fittings are full flow fittings made of ductile iron except those marked () which are full flow 1½ D fabricated steel.

22½° Elbows Fig. 7052



For listing/approval details contact your Gruvlok Representative.

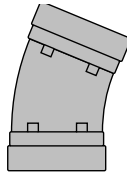

Nominal Pipe Size (Inches)	Aprx. Weight Each (Lbs.)	Price Each	
		Painted	Galvanized
1*	0.5	\$37.35	\$45.79
1¼*	0.7	\$37.35	\$45.79
1½*	0.8	\$37.35	\$45.79
2	1.5	\$37.35	\$45.79
2½*	1.9	\$37.35	\$45.79
3	3.2	\$54.52	\$65.75
3½*	4.0	\$130.11	\$165.85
4	5.3	\$73.02	\$90.05
5*	7.2	\$226.12	\$260.02
6	8.2	\$206.52	\$250.62
8	17.8	\$431.97	\$511.00
10*	30.0	\$592.91	\$740.05
12*	40.4	\$801.47	\$945.61
14*	46.0	\$925.72	\$992.43
16*	52.2	\$1,110.30	\$1,202.98
18*	65.0	\$1,336.84	\$1,438.20
20*	80.0	\$1,589.66	\$1,720.66
24*	112.0	\$2,135.97	\$2,381.61

11¼° Elbows Fig. 7053



For listing/approval details contact your Gruvlok Representative.

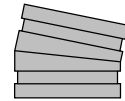

Nominal Pipe Size (Inches)	Aprx. Weight Each (Lbs.)	Price Each	
		Painted	Galvanized
1*	0.3	\$79.48	\$97.53
1¼*	0.5	\$37.35	\$45.79
1½*	0.7	\$37.35	\$45.79
2*	0.9	\$88.80	\$98.78
2½*	1.5	\$88.80	\$98.78
3*	2.0	\$54.52	\$64.81
3½*	2.8	\$130.11	\$146.19
4*	3.3	\$67.29	\$85.63
5*	5.0	\$226.12	\$253.34
6*	6.5	\$206.52	\$237.64
8*	10.0	\$368.92	\$417.51
10*	14.5	\$553.20	\$628.43
12*	18.7	\$801.47	\$923.67
14*	32.1	\$836.56	\$884.91
16*	42.0	\$1,031.33	\$1,121.38
18*	53.2	\$1,248.71	\$1,364.74
20*	65.7	\$1,461.61	\$1,581.75
24*	96.0	\$2,071.62	\$2,328.70

Gruvlok fittings are full flow fittings made of ductile iron except those marked () which are full flow 1½ D fabricated steel.

Tees Fig. 7060



For listing/approval details contact your Gruvlok Representative.

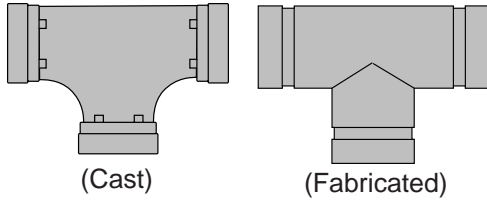

Tees with Threaded Branch*, Fig. 7063



For listing/approval details contact your Gruvlok Representative.

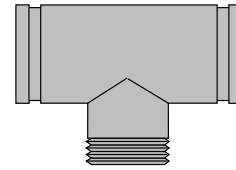

Grooved-End Couplings

Fittings

Valves and Accessories

Spare Parts

Plain-End

Copper Method

Tools

Nominal Pipe Size (Inches)	Aprx. Weight Each (Lbs.)	Price Each	
		Painted	Galvanized
1	0.9	\$53.65	\$67.22
1¼	1.5	\$53.65	\$67.22
1½	1.8	\$53.65	\$67.22
2	2.4	\$53.65	\$67.22
2½	4.0	\$53.65	\$67.22
3	5.8	\$75.06	\$98.49
3½	9.8	\$308.02	\$336.27
4	10.3	\$114.48	\$148.31
5	16.2	\$268.96	\$325.18
6	25.7	\$310.66	\$402.61
8	41.1	\$682.37	\$852.04
10	74.5	\$1,418.00	\$1,418.00
12	94.7	\$1,977.09	\$2,401.87
14*	118.0	\$2,095.32	\$2,481.56
16*	146.0	\$2,367.29	\$2,857.83
18*	218.0	\$2,958.15	\$3,627.08
20*	275.0	\$4,238.93	\$5,110.35
24*	379.0	\$6,463.02	\$7,971.32

Nominal Pipe Size (Inches)	Aprx. Weight Each (Lbs.)	Price Each	
		Painted	Galvanized
1*	0.9	\$80.36	\$95.40
1¼*	1.4	\$80.36	\$95.40
1½*	1.7	\$80.36	\$95.40
2*	2.9	\$80.36	\$95.40
2½*	4.7	\$80.36	\$95.40
3*	8.1	\$120.95	\$147.14
4*	13.5	\$172.17	\$210.11
5*	16.7	\$412.81	\$479.46
6*	25.6	\$430.49	\$533.24
8*	45.0	\$666.37	\$835.02
10*	73.0	\$1,059.95	\$1,363.64
12*	98.0	\$1,590.11	\$1,954.49

Gruvlok fittings are full flow fittings made of ductile iron except those marked () which are full flow fabricated steel.

Gruvlok fittings are full flow fittings made of ductile iron except those marked () which are full flow fabricated steel.

Reducing Tees Fig. 7061

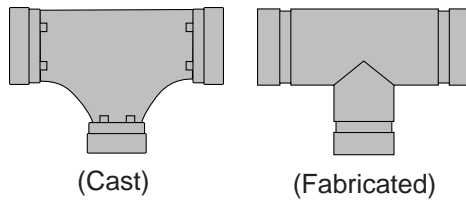

Nominal Pipe Size (Inches)	Branch	Aprx. Weight Each (Lbs.)	Price Each	
			Painted	Galv.
1 1/4 x 1 1/4	x 1*	1.5	\$96.57	\$104.66
1 1/2 x 1 1/2	x 1*	1.8	\$98.85	\$104.66
	x 1 1/4*	1.8	\$101.65	\$107.15
2 x 2	x 1	2.6	\$115.82	\$130.64
	x 1 1/4*	1.7	\$115.82	\$129.75
	x 1 1/2	2.7	\$115.82	\$130.64
2 1/2 x 2 1/2	x 1*	4.1	\$115.82	\$129.75
	x 1 1/4*	4.2	\$136.94	\$147.58
	x 1 1/2*	4.3	\$115.82	\$131.37
	x 2*	4.4	\$115.82	\$131.37
3 x 3	x 1*	7.0	\$102.16	\$124.53
	x 1 1/4*	5.8	\$144.20	\$160.06
	x 1 1/2*	5.9	\$102.16	\$124.53
	x 2	5.5	\$102.16	\$125.34
	x 2 1/2*	6.3	\$102.16	\$125.34
4 x 4	x 1*	7.0	\$137.97	\$164.39
	x 1 1/4*	9.6	\$200.28	\$233.82
	x 1 1/2*	10.2	\$137.97	\$164.39
	x 2	10.2	\$137.97	\$172.90
	x 2 1/2	11.2	\$137.97	\$172.90
	x 3	11.4	\$137.97	\$172.90
5 x 5	x 1*	13.6	\$305.95	\$358.44
	x 1 1/2*	13.8	\$316.30	\$373.19
	x 2*	14.0	\$336.86	\$395.71
	x 2 1/2*	14.3	\$273.75	\$328.42
	x 3*	14.6	\$273.75	\$328.42
	x 4*	17.9	\$296.78	\$357.11
6 x 6	x 1*	20.5	\$369.07	\$430.49
	x 1 1/2*	21.0	\$381.48	\$462.79
	x 2*	26.4	\$326.81	\$408.62
	x 2 1/2*	26.5	\$326.81	\$408.62
	x 3*	26.5	\$326.81	\$408.62
	x 4*	26.5	\$326.81	\$408.62
	x 5	28.0	\$326.81	\$411.12
8 x 8	x 1 1/2*	33.0	\$472.04	\$545.94
	x 2*	32.7	\$472.04	\$566.48
	x 2 1/2*	33.0	\$472.04	\$562.01
	x 3*	32.5	\$472.04	\$578.09
	x 4	50.0	\$682.37	\$838.84
	x 5*	34.7	\$682.37	\$844.71
	x 6	54.0	\$682.37	\$847.92

Nominal Pipe Size (Inches)	Branch	Aprx. Weight Each (Lbs.)	Price Each	
			Painted	Galv.
10 x 10	x 1 1/2*	52.0	\$822.53	\$970.26
	x 2*	52.2	\$822.53	\$980.17
	x 2 1/2*	52.6	\$822.53	\$986.05
	x 3*	53.0	\$822.53	\$1,000.08
	x 4*	53.6	\$859.60	\$1,045.27
	x 5*	54.2	\$879.05	\$1,067.29
	x 6	55.0	\$879.05	\$1,080.94
	x 8	64.7	\$894.98	\$1,122.48
12 x 12	x 1*	77.0	\$1,107.59	\$1,278.72
	x 2*	80.0	\$1,107.59	\$1,295.01
	x 2 1/2*	78.0	\$1,107.59	\$1,320.11
	x 3*	74.6	\$1,107.59	\$1,347.99
	x 4*	75.1	\$1,186.98	\$1,449.72
	x 5*	75.6	\$1,254.73	\$1,550.11
	x 6*	76.2	\$1,269.69	\$1,564.78
	x 8*	76.3	\$1,305.44	\$1,600.74
	x 10*	77.6	\$1,366.27	\$1,675.47
14 x 14	x 4*	100.0	\$1,256.69	\$1,524.13
	x 6*	101.0	\$1,315.57	\$1,604.49
	x 8*	103.0	\$1,347.33	\$1,630.76
	x 10*	104.0	\$1,425.42	\$1,727.56
	x 12*	105.0	\$1,525.46	\$1,858.27
16 x 16	x 4*	126.0	\$1,504.09	\$1,864.88
	x 6*	127.0	\$1,627.09	\$1,998.44
	x 8*	128.0	\$1,713.12	\$2,065.24
	x 10*	129.0	\$1,851.45	\$2,231.23
	x 12*	130.0	\$1,888.81	\$2,281.72
	x 14*	132.0	\$2,211.50	\$2,605.29
18 x 18	x 4*	188.0	\$2,092.96	\$2,518.99
	x 6*	190.0	\$2,121.08	\$2,582.69
	x 8*	192.0	\$2,184.04	\$2,635.32
	x 10*	194.0	\$2,266.68	\$2,775.77
	x 12*	196.0	\$2,266.68	\$2,791.93
	x 14*	201.0	\$2,622.61	\$3,194.09
	x 16*	203.0	\$2,862.15	\$3,424.01
20 x 20	x 6*	240.0	\$2,481.04	\$3,178.89
	x 8*	242.0	\$2,858.92	\$3,595.82
	x 10*	244.0	\$2,897.16	\$3,637.28
	x 12*	246.0	\$3,241.72	\$3,920.34
	x 14*	248.0	\$3,491.46	\$4,209.94
	x 16*	250.0	\$3,745.39	\$4,496.52
	x 18*	252.0	\$4,118.86	\$4,932.66
24 x 24	x 8*	327.0	\$4,339.18	\$5,415.05
	x 10*	330.0	\$4,553.03	\$5,670.07
	x 12*	334.0	\$4,684.55	\$5,833.80
	x 14*	340.0	\$5,221.59	\$6,443.66
	x 16*	342.0	\$5,339.39	\$6,593.60
	x 18*	345.0	\$5,228.57	\$6,434.49
	x 20*	347.0	\$5,676.31	\$6,963.77

Gruvlok fittings are full flow fittings made of ductile iron except those marked () which are fabricated steel.

Reducing Tee with Threaded Branch Fig. 7064



For listing/approval details contact your Gruvlok Representative.

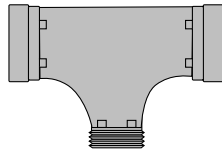

(Cast)

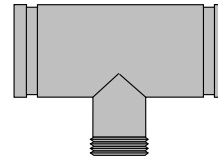

(Fabricated)

Nominal Pipe Size (Inches)	Branch	Aprx. Weight Each (Lbs.)	Price Each	
			Painted	Galv.
2 x 2	x 3/4*	1.6	\$134.89	\$150.44
	x 1	2.6	\$122.62	\$136.72
	x 1 1/4*	1.7	\$122.62	\$136.72
	x 1 1/2	2.7	\$122.62	\$138.56
2 1/2 x 2 1/2	x 1*	4.1	\$122.62	\$136.72
	x 1 1/2*	4.3	\$122.62	\$138.56
	x 2*	4.4	\$122.62	\$139.44
3 x 3	x 3/4*	5.7	\$153.09	\$158.96
	x 1	7.0	\$122.62	\$145.97
	x 1 1/2*	5.3	\$122.62	\$146.48
	x 2*	5.5	\$122.62	\$146.92
	x 2 1/2*	5.8	\$211.80	\$236.97
4 x 4	x 3/4*	7.2	\$218.48	\$226.19
	x 1*	7.0	\$153.16	\$180.39
	x 1 1/2*	9.2	\$153.16	\$182.96
	x 2*	10.2	\$153.16	\$182.96
	x 2 1/2	11.2	\$153.16	\$188.54
5 x 5	x 3*	11.4	\$153.16	\$189.28
	x 2*	14.5	\$251.81	\$301.70
	x 3*	16.1	\$273.75	\$328.42
	x 4*	17.9	\$296.78	\$357.11
6 x 6	x 2*	26.4	\$384.84	\$456.33
	x 2 1/2*	26.5	\$384.84	\$456.33
	x 3*	26.5	\$384.84	\$456.33
	x 4*	26.5	\$384.84	\$456.33
	x 5	28.0	\$384.84	\$456.33
8 x 8	x 2*	37.5	\$472.04	\$578.09
	x 3*	38.7	\$472.04	\$578.09
	x 4*	50.0	\$682.37	\$838.84
	x 5*	41.0	\$682.37	\$843.75
	x 6*	54.0	\$682.37	\$847.92

Nominal Pipe Size (Inches)	Branch	Aprx. Weight Each (Lbs.)	Price Each	
			Painted	Galv.
10 x 10	x 2*	61.8	\$822.39	\$970.20
	x 3*	63.0	\$822.39	\$970.20
	x 4*	64.0	\$859.60	\$1,045.27
	x 5*	65.1	\$879.05	\$1,067.29
	x 6*	55.0	\$879.05	\$1,080.94
12 x 12	x 8*	64.7	\$894.98	\$1,122.48
	x 3*	84.9	\$1,107.59	\$1,360.34
	x 4*	85.8	\$1,186.91	\$1,449.72
	x 5*	87.0	\$1,254.73	\$1,550.19
14 x 14	x 6*	88.3	\$1,269.69	\$1,564.78
	x 8*	91.2	\$1,305.44	\$1,600.74
	x 10*	94.8	\$1,366.27	\$1,603.32
	x 8	110.0	POA	POA
16 x 16	x 10	114.0	POA	POA
	x 12	117.0	POA	POA
	x 8	135.0	POA	POA
18 x 18	x 10	139.0	POA	POA
	x 12	142.0	POA	POA
	x 10	204.0	POA	POA
24 x 24	x 12	209.0	POA	POA
	x 14	211.0	POA	POA
	x 16	216.0	POA	POA
	x 8	334.0	POA	POA
	x 10	342.0	POA	POA
	x 12	349.0	POA	POA

Gruvlok fittings are full flow fittings made of ductile iron except those marked () which are fabricated steel.

Grooved-End Couplings

Fittings

Valves and Accessories

Spare Parts

Plain-End

Copper Method

Tools

Concentric Reducer Fig. 7072, Groove by Groove (Gr x Gr)

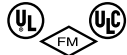

For listing/approval details contact your Gruvlok Representative.

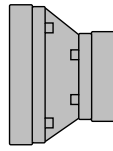

(Cast)

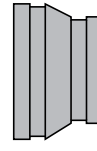

(Weld)

Nominal Pipe Size (Inches)		Aprx. Weight Each (Lbs.)	Price Each		
			Painted	Galv.	
1 1/4	x 1*	0.6	\$167.11	\$175.47	
1 1/2	x 1*	0.6	\$40.59	\$45.43	
	x 1 1/4*	0.6	\$40.59	\$45.43	
2	x 1*	0.8	\$40.59	\$45.43	
	x 1 1/4	1.3	\$44.62	\$50.06	
	x 1 1/2	1.3	\$40.59	\$45.43	
2 1/2	x 1*	1.0	\$40.59	\$45.43	
	x 1 1/4*	1.0	\$258.03	\$269.86	
	x 1 1/2*	1.3	\$40.59	\$45.43	
3	x 2	1.6	\$40.59	\$45.43	
	x 1*	1.2	\$44.76	\$51.66	
	x 1 1/4*	1.3	\$256.42	\$273.67	
	x 1 1/2*	1.3	\$49.03	\$56.95	
	x 2	1.4	\$35.53	\$41.46	
3 1/2	x 2 1/2*	1.6	\$49.03	\$56.51	
	x 3*	1.5	\$52.18	\$59.96	
	4	x 1	2.2	\$53.79	\$63.26
		x 1 1/4*	2.2	\$424.05	\$451.78
		x 1 1/2*	2.3	\$324.30	\$337.59
		x 2	2.4	\$47.49	\$56.06
x 2 1/2		2.6	\$59.29	\$69.13	
5	x 3	3.2	\$59.29	\$69.13	
	x 3 1/2	3.6	\$59.29	\$69.13	
	x 2*	4.6	\$596.80	\$626.95	
	x 2 1/2*	4.5	\$463.08	\$477.76	
6	x 3*	4.4	\$69.36	\$81.60	
	x 4	4.5	\$82.79	\$98.78	
	x 1*	6.8	\$110.09	\$130.49	
	x 1 1/2*	6.9	\$627.47	\$663.44	
	x 2	6.0	\$110.09	\$130.49	
6	x 2 1/2*	6.0	\$122.62	\$143.41	
	x 3	5.4	\$110.09	\$130.49	
	x 4	5.6	\$95.84	\$118.44	
	x 5	6.0	\$141.79	\$168.42	

Nominal Pipe Size (Inches)		Aprx. Weight Each (Lbs.)	Price Each	
			Painted	Galv.
8	x 3*	12.0	\$196.61	\$233.46
	x 4	9.0	\$196.61	\$234.77
	x 5*	11.5	\$196.61	\$236.16
10	x 6	10.6	\$250.62	\$298.47
	x 4*	20.0	\$467.86	\$548.20
	x 5*	20.0	\$1,031.10	\$1,118.95
12	x 6*	20.0	\$511.59	\$607.22
	x 8*	23.9	\$511.59	\$617.20
	x 6*	29.0	\$610.15	\$717.67
14	x 8*	29.0	\$916.48	\$1,029.65
	x 10*	32.4	\$916.48	\$1,079.91
	x 6*	54.3	\$3,463.79	\$3,570.20
16	x 8*	54.5	\$1,962.63	\$2,064.94
	x 10*	55.7	\$1,715.02	\$1,820.25
	x 12*	57.3	\$1,877.87	\$2,013.06
	x 14*	57.3	\$1,877.87	\$2,013.06
18	x 8*	65.4	\$2,811.81	\$2,915.80
	x 10*	66.7	\$2,701.64	\$2,878.29
	x 12*	68.1	\$2,738.05	\$2,932.75
	x 14*	76.0	\$2,738.05	\$2,968.64
20	x 10*	82.3	\$3,750.22	\$3,929.96
	x 12*	83.6	\$3,850.25	\$3,427.39
	x 14*	86.2	\$3,117.84	\$3,240.46
	x 16*	87.2	\$3,117.84	\$3,735.63
24	x 10*	123.0	\$4,046.58	\$4,462.89
	x 12*	125.0	\$4,196.36	\$4,464.74
	x 14*	129.0	\$3,800.72	\$4,068.38
	x 16*	131.0	\$3,390.84	\$3,569.33
24	x 18*	133.0	\$3,264.03	\$3,583.28
	x 10*	147.0	\$9,017.11	\$9,537.64
	x 12*	149.0	\$8,799.29	\$9,337.74
	x 14*	152.0	\$7,650.39	\$7,873.71
	x 16*	153.0	\$7,650.39	\$7,873.71
24	x 18*	154.0	\$6,696.71	\$6,927.73
	x 20*	155.0	\$6,200.82	\$6,411.95

Gruvlok fittings are full flow fittings made of ductile iron except those marked () which are fabricated steel.

Cap Fig. 7074



For listing/approval details contact your Gruvlok Representative.



Nominal Pipe Size (Inches)	Aprx. Weight Each (Lbs.)	Price Each	
		Painted	Galvanized
1	0.3	\$28.70	\$33.39
1¼	0.4	\$28.70	\$33.39
1½	0.5	\$28.70	\$33.39
2	0.5	\$28.70	\$33.39
2½	0.7	\$28.70	\$33.39
3	1.1	\$28.70	\$33.39
3½	1.4	\$31.21	\$39.56
4	2.8	\$31.21	\$39.56
5	4.0	\$73.02	\$90.71
6	6.0	\$74.78	\$95.40
8	12.5	\$143.47	\$181.33
10	21.9	\$303.98	\$376.42
12	33.8	\$497.95	\$603.25
14*	40.0	\$1,075.07	\$1,170.47
16*	45.0	\$1,216.72	\$1,381.84
18*	58.0	\$1,409.21	\$1,583.06
20*	79.0	\$1,599.95	\$1,817.10
24*	100.0	\$2,178.99	\$2,396.14

*Fabricated Steel

**Concentric Reducer Fig. 7076
Groove by Thread (Gr x Thd)**



For listing/approval details contact your Gruvlok Representative.

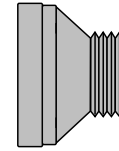

(Weld)

Nominal Pipe Size (Inches)	Aprx. Weight Each (Lbs.)	Price Each		
		Painted	Galv.	
1½	x 1*	0.6	\$42.04	\$49.62
2	x ¾*	1.0	\$42.04	\$49.62
	x 1	0.8	\$42.04	\$49.62
	x 1¼	1.3	\$42.04	\$49.62
	x 1½	1.3	\$42.04	\$49.62
2½	x 1*	1.0	\$248.79	\$252.24
	x 1¼*	1.0	\$63.05	\$71.25
	x 1½*	1.3	\$63.05	\$71.25
	x 2	1.2	\$42.04	\$49.62
3	x ¾*	1.2	\$311.47	\$315.65
	x 1*	1.2	\$46.38	\$52.83
	x 1½*	1.3	\$52.18	\$59.66
	x 2	1.3	\$52.18	\$59.66
4	x 2½	1.5	\$63.05	\$71.25
	x 1*	2.2	\$59.88	\$69.13
	x 1½*	2.3	\$339.28	\$347.94
	x 2*	2.4	\$63.26	\$73.02
5	x 2½	2.3	\$64.23	\$75.00
	x 3	2.6	\$78.08	\$88.80
	x 4	4.5	\$452.22	\$467.86
	6	x 1*	6.0	\$122.62
x 2		6.0	\$122.62	\$143.41
x 3		6.0	\$122.62	\$143.41
x 4		5.9	\$122.62	\$143.41
x 5		5.8	\$122.62	\$143.41
8	x 3*	9.3	\$198.37	\$235.58
	x 4	10.4	\$198.37	\$235.58
	x 5*	11.6	\$198.37	\$238.37
	x 6	11.9	\$252.89	\$301.33
10	x 4*	19.7	\$472.32	\$553.50
	x 5	34.3	\$1,040.95	\$1,129.60
	x 6	20.0	\$516.44	\$612.94
	x 8*	22.1	\$516.44	\$623.07
12	x 4*	44.0	POA	POA
	x 6	24.6	POA	POA
	x 8*	52.0	POA	POA
	x 10*	38.0	POA	POA

*Fabricated Steel

Reducer sizes not shown, will be priced on application.

**Hose Nipple Fig. 7086
Groove by Hose (Gr x Hose)**

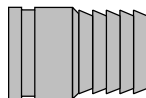

Nominal Pipe Size (Inches)	Aprx. Weight Each (Lbs.)	Price Each	
		Painted	Galvanized
1	0.4	\$68.76	\$78.23
1¼	0.7	\$68.76	\$78.23
1½	0.8	\$68.76	\$78.23
2	1.3	\$68.76	\$78.23
2½	2.1	\$68.76	\$78.23
3	3.3	\$99.22	\$113.97
4	5.5	\$174.14	\$199.38
5	8.1	\$263.76	\$300.53
6	13.2	\$313.58	\$364.52
8	24.0	\$652.57	\$752.09
10	29.0	\$665.19	\$771.38
12	46.0	\$728.23	\$859.96

Grooved-End Couplings

Fittings

Valves and Accessories

Spare Parts

Plain-End

Copper Method

Tools

Eccentric Reducer Fig. 7073 and Figure 7097



For listing/approval details contact your Gruvlok Representative.

Fig. 7073
GR x GR



(Fabricated)

Fig. 7097
GR x THD

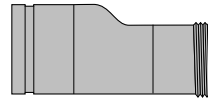

(Fabricated)

Nominal Pipe Size (Inches)		Aprx. Weight Each (Lbs.)	Price Each	
			Painted	Galv.
1 1/4	x 1	1.5	\$176.28	\$196.76
1 1/2	x 3/4	1.6	\$195.35	\$200.28
	x 1	1.7	\$176.28	\$196.76
	x 1 1/4	4.5	\$172.39	\$189.78
2	x 3/4	2.1	\$379.26	\$392.92
	x 1	2.2	\$194.70	\$208.35
	x 1 1/4	2.4	\$213.42	\$223.90
	x 1 1/2	2.5	\$178.63	\$196.54
2 1/2	x 1	3.2	\$461.39	\$485.53
	x 1 1/4	3.4	\$267.94	\$289.23
	x 1 1/2	3.6	\$212.46	\$230.89
	x 2	4.0	\$85.63	\$111.77
3	x 1	4.0	\$494.93	\$517.60
	x 1 1/4	4.3	\$448.04	\$469.32
	x 1 1/2	4.5	\$245.56	\$272.93
	x 2	4.8	\$98.35	\$128.50
	x 2 1/2	5.6	\$98.35	\$131.29
3 1/2	x 3	6.6	\$543.74	\$567.74
4	x 1	5.9	\$1,002.85	\$1,023.48
	x 1 1/2	6.4	\$606.55	\$623.00
	x 2	6.7	\$120.21	\$160.14
	x 2 1/2	7.3	\$120.21	\$160.14
	x 3	7.9	\$120.21	\$160.14
5	x 2	9.3	\$668.79	\$688.10
	x 2 1/2	9.9	\$569.86	\$600.91
	x 3	10.7	\$550.49	\$584.10
	x 4	11.9	\$163.74	\$220.45
6	x 1	12.0	\$1,039.77	\$1,073.53
	x 2	12.2	\$948.26	\$981.80
	x 2 1/2	12.8	\$1,128.94	\$1,169.16
	x 3	13.6	\$218.03	\$291.20
	x 4	14.9	\$190.88	\$267.21
	x 5	16.2	\$228.89	\$309.77

Nominal Pipe Size (Inches)		Aprx. Weight Each (Lbs.)	Price Each	
			Painted	Galv.
8	x 3	17.9	\$1,101.72	\$1,140.68
	x 4	19.7	\$962.78	\$1,044.33
	x 5	21.4	\$896.37	\$979.38
	x 6	23.2	\$386.83	\$501.25
10	x 4	29.7	\$1,766.67	\$2,015.24
	x 5	31.7	\$1,664.39	\$1,862.68
	x 6	34.0	\$1,255.09	\$1,414.80
	x 8	34.4	\$1,062.37	\$1,256.55
12	x 6	45.2	\$1,676.77	\$1,920.28
	x 8	47.7	\$1,633.85	\$1,859.74
	x 10	52.0	\$1,463.44	\$1,650.22
14	x 6	78.0	\$4,230.40	\$4,325.96
	x 8	80.0	\$3,203.04	\$3,315.71
	x 10	84.0	\$2,929.60	\$3,046.80
	x 12	88.0	\$2,845.42	\$2,959.24
16	x 8	91.0	\$4,672.06	\$4,776.21
	x 10	96.0	\$4,317.39	\$4,421.58
	x 12	99.0	\$4,246.11	\$4,416.07
	x 14	104.0	\$4,155.39	\$4,321.64
18	x 10	110.0	\$5,871.90	\$6,002.23
	x 12	113.0	\$5,513.77	\$5,537.46
	x 14	117.0	\$5,009.65	\$5,128.69
	x 16	121.0	\$5,009.65	\$5,393.84
20	x 10	145.0	\$7,818.01	\$8,362.12
	x 12	149.0	\$5,723.59	\$6,008.38
	x 14	152.0	\$5,679.61	\$5,906.83
	x 16	156.0	\$5,278.91	\$5,504.73
24	x 18	160.0	\$5,076.66	\$5,439.26
	x 12	174.0	\$3,264.03	\$11,714.65
	x 14	184.0	\$9,017.11	\$9,829.89
	x 16	189.0	\$9,546.76	\$9,844.86
	x 18	194.0	\$9,004.85	\$9,273.96
	x 20	199.0	\$8,217.38	\$8,500.89

All fabricated steel.
Reducer sizes not shown will be priced on application.

90° Long Radius Elbows

Fig. 7050 LR (1½"D)



For listing/approval details contact your Gruklok Representative.

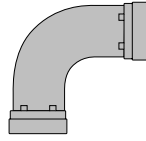

Nominal Pipe Size (Inches)	Aprx. Weight Each (Lbs.)	Price Each	
		Painted	Galvanized
1	0.9	\$14.02	\$18.20
1¼	1.3	\$14.90	\$19.37
1½	1.7	\$83.57	\$81.87
2	2.5	\$80.21	\$100.02
2½	4.9	\$232.64	\$237.41
3	6.5	\$80.21	\$100.02
3½	9.7	\$49.76	\$64.66
4	11.5	\$120.14	\$153.09
5	20.9	\$615.15	\$670.55
6	29.1	\$351.09	\$439.53
8	59.2	\$842.14	\$1,024.35
10	104.0	\$1,745.99	\$2,001.52
12	147.0	\$2,846.23	\$3,186.75
14	169.0	\$2,096.35	\$2,587.31
16	222.0	\$2,723.08	\$3,349.01
18	280.0	\$3,454.61	\$4,096.03
20	344.0	\$4,556.04	\$5,375.93
24	490.0	\$6,597.84	\$7,810.53

All fabricated steel fittings.

45° Long Radius Elbows

Fig. 7051 LR (1½"D)



For listing/approval details contact your Gruklok Representative.

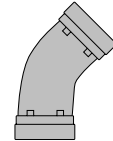

Nominal Pipe Size (Inches)	Aprx. Weight Each (Lbs.)	Price Each	
		Painted	Galvanized
1	0.7	\$12.62	\$16.44
1¼	1.0	\$12.92	\$16.81
1½	1.2	\$77.02	\$71.04
2	1.7	\$69.65	\$84.24
2½	2.9	\$224.57	\$240.94
3	4.3	\$69.65	\$84.24
3½	5.0	\$45.58	\$59.29
4	7.2	\$84.76	\$107.52
5	12.2	\$571.69	\$596.43
6	17.4	\$252.31	\$307.29
8	34.0	\$438.65	\$542.71
10	57.4	\$1,309.11	\$1,467.92
12	82.6	\$1,515.92	\$1,769.84
14	92.0	\$1,569.57	\$1,911.48
16	117.0	\$1,766.91	\$2,085.63
18	146.0	\$2,071.02	\$2,413.03
20	179.0	\$2,721.02	\$3,180.52
24	255.0	\$4,179.03	\$4,843.20

All fabricated steel fittings.

Reducing Base Support Elbows
Fig. 7050RF (Grooved x Flanged (G x F))

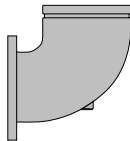

Nominal Pipe Size (Inches)	Aprx. Weight Each (Lbs.)	Price Each Black
6 x 5	45.4	\$733.59
8 x 5	65.5	\$985.40
8 x 6	73.0	\$985.40
10 x 6	100.0	\$1,476.13
10 x 8	127.0	\$1,476.13
12 x 8	155.0	POA
12 x 10	186.0	POA

All fabricated steel fittings.

Female Thread Adapter Fig. 7087



Nominal Pipe Size (Inches)	End to End Length (Inches)	Aprx. Weight Each (Lbs.)	Price Each	
			Painted	Galv.
1	2¼	0.7	\$62.53	\$70.23
1¼	2⅝	1.4	\$62.53	\$70.23
1½	2⅝	1.5	\$62.53	\$70.23
2	2½	1.6	\$62.53	\$70.23
2½	—	1.6	\$62.53	\$70.23
3	2¾	2.5	\$73.02	\$85.20
4	3¼	4.5	\$112.36	\$133.94

Grooved-End Couplings

Fittings

Valves and Accessories

Spare Parts

Plain-End

Copper Method

Tools

Tee WYE Fig. 7066



For listing/approval details contact your Gruvlok Representative.

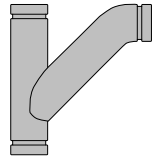

Nominal Pipe Size (Inches)	Length (Inches)	Aprx. Weight Each (Lbs.)	Price Each	
			Painted	Galv.
2 x 2	x 2	6.4	\$371.19	\$420.74
2½ x 2½	x 2½	11.5	\$371.19	\$420.74
3 x 3	x 3	16.5	\$425.51	\$489.06
3½ x 3½	x 3½	22.0	\$550.13	\$632.67
4 x 4	x 3	23.0	\$513.43	\$591.00
	x 4	26.0	\$591.06	\$684.51
5 x 5	x 3	32.0	\$567.89	\$670.34
	x 4	35.0	\$683.61	\$800.52
	x 5	40.0	\$920.15	\$1,076.90
6 x 6	x 3	50.0	\$608.68	\$747.68
	x 4	55.0	\$742.03	\$882.73
	x 5	58.0	\$1,014.45	\$1,193.44
	x 6	60.5	\$1,130.26	\$1,328.98
8 x 8	x 3	100.0	\$725.15	\$966.08
	x 4	110.0	\$864.23	\$1,133.27
	x 5	111.0	\$1,144.27	\$1,432.47
	x 6	112.0	\$1,248.41	\$1,552.16
	x 8	120.0	\$1,720.52	\$2,074.76
10 x 10	x 3	130.0	\$999.69	\$1,318.20
	x 4	135.0	\$1,096.49	\$1,432.47
	x 5	140.0	\$1,381.77	\$1,747.60
	x 6	145.0	\$1,455.38	\$1,835.59
	x 8	150.0	\$1,887.62	\$2,309.98
12 x 12	x 10	190.0	\$2,465.57	\$3,007.01
	x 12	240.0	\$3,400.97	\$4,106.17

Gruvlok Tee Wyes and Reducing Tee Wye's are fabricated steel.

Lateral Fig. 7069



For listing/approval details contact your Gruvlok Representative.

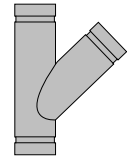

Nominal Pipe Size (Inches)	Aprx. Weight Each (Lbs.)	Price Each	
		Painted	Galvanized
1	1.5	\$213.04	\$248.42
1¼	2.5	\$213.04	\$248.42
1½	3.5	\$213.04	\$248.42
2	4.5	\$213.04	\$248.42
2½	10.0	\$213.04	\$248.42
3	11.0	\$235.21	\$282.33
3½	14.0	\$311.76	\$373.12
4	18.3	\$362.84	\$430.42
5	30.0	\$530.38	\$633.20
6	46.6	\$854.39	\$976.14
8	82.8	\$1,230.57	\$1,418.61
10	127.0	\$1,736.81	\$1,915.88
12	165.0	\$2,099.86	\$2,530.08
14	215.0	\$3,064.86	\$3,739.44
16	345.0	\$3,828.03	\$4,676.16
18	425.0	\$4,279.86	\$5,290.29
20	517.0	\$6,491.95	\$7,822.34
24	940.0	\$10,087.77	\$12,377.27

Gruvlok Laterals are fabricated steel.

Bullhead Plug Fig. 7075

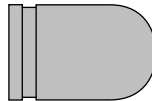

Nominal Pipe Size (Inches)	Aprx. Weight Each (Lbs.)	Price Each
2	2.5	\$110.30
2½	3.1	\$110.30
3	4.4	\$161.60
4	7.4	\$208.86
5*	12.5	\$456.25
6	18.5	\$492.14

Galvanized and other sizes priced on application.

*Fabricated steel.

Steel Cross Fig. 7068 & True Y Fig. 7071



For listing/approval details contact your Gruvlok Representative.

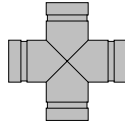

Steel Cross Fig. 7068

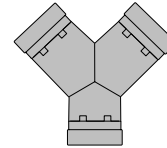

True Y Fig. 7071

Nominal Pipe Size (Inches)	Aprx. Weight Each (Lbs.)	Price Each		Aprx. Weight Each (Lbs.)	Price Each	
		Painted	Galvanized		Painted	Galvanized
1	1.3	\$132.39	\$145.24	1.1	\$204.47	\$231.03
1¼	2.1	\$159.71	\$177.23	1.5	\$204.47	\$231.03
1½	2.5	\$172.17	\$190.15	1.8	\$204.47	\$231.03
2	2.9	\$97.39	\$110.82	2.3	\$204.47	\$231.03
2½	5.2	\$97.39	\$110.82	5.0	\$204.47	\$231.03
3	7.5	\$174.89	\$204.03	6.1	\$244.39	\$275.79
3½	9.8	\$352.93	\$400.63	8.3	\$261.48	\$320.34
4	12.2	\$290.98	\$340.82	10.5	\$320.06	\$366.43
5	17.6	\$594.30	\$681.93	15.0	\$458.61	\$524.80
6	28.3	\$764.56	\$882.37	21.6	\$567.52	\$657.04
8	48.0	\$1,006.82	\$1,184.64	36.0	\$817.33	\$955.59
10	70.0	\$1,717.21	\$2,019.80	51.0	\$1,410.59	\$1,643.24
12	110.0	\$2,478.04	\$2,936.28	160.0	\$1,558.33	\$1,874.70
14	140.0	\$2,567.43	\$2,988.22	136.0	\$1,779.38	\$2,123.21
16	170.0	\$3,358.48	\$3,888.94	166.0	\$2,311.15	\$2,756.03
18	260.0	\$4,116.65	\$4,838.15	234.0	\$2,643.67	\$3,223.67
20	320.0	\$5,832.10	\$6,776.19	281.0	\$3,834.19	\$4,580.55
24	585.0	\$9,003.45	\$10,974.45	523.0	\$5,961.06	\$7,260.85

Reducing Lateral — Fig. 7070

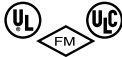

For listing/approval details contact your Gruvlok Representative.

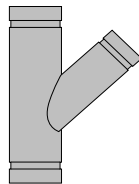

Nominal Pipe Size (Inches)	Length (Inches)	Aprx. Weight Each (Lbs.)	Price Each	
			Painted	Galv.
12 x 12	x 4	130.0	POA	POA
	x 5	137.0	\$1,457.49	\$1,841.04
	x 6	140.0	\$1,457.49	\$1,855.42
	x 8	147.0	\$1,476.50	\$1,897.24
	x 10	168.0	\$1,495.96	\$1,959.47
14 x 14	x 4	173.0	\$1,413.75	\$1,867.08
	x 6	185.0	\$1,508.65	\$1,996.46
	x 8	195.0	\$1,624.10	\$2,147.78
	x 10	223.0	\$1,779.45	\$2,360.69
16 x 16	x 12	240.0	\$1,918.38	\$2,545.70
	x 6	235.0	\$1,842.05	\$2,455.36
	x 8	250.0	\$1,921.61	\$2,569.19
	x 10	263.0	\$2,085.91	\$2,770.27
18 x 18	x 12	283.0	\$2,241.37	\$2,980.24
	x 14	307.0	\$2,565.37	\$3,376.16
	x 6	275.0	\$2,578.29	\$3,219.05
	x 8	306.0	\$2,680.82	\$3,379.32
20 x 20	x 10	321.0	\$3,010.99	\$4,051.56
	x 12	333.0	\$3,010.99	\$3,779.37
	x 14	358.0	\$3,605.74	\$4,459.08
	x 16	382.0	\$4,056.04	\$4,982.72
24 x 24	x 12	390.0	\$4,206.78	\$5,826.75
	x 14	410.0	\$4,907.48	\$5,946.61
	x 16	440.0	\$5,255.36	\$6,367.04
24 x 24	x 16	725.0	\$7,015.64	\$8,758.63
	x 20	785.0	\$8,495.30	\$10,411.77

Nominal Pipe Size (Inches)	Length (Inches)	Aprx. Weight Each (Lbs.)	Price Each	
			Painted	Galv.
3 x 3	x 2	9.8	\$184.06	\$218.70
	x 2½	11.5	\$184.06	\$222.15
4 x 4	x 2	15.5	\$362.84	\$411.12
	x 2½	17.0	\$362.84	\$425.72
	x 3	18.5	\$362.84	\$429.98
5 x 5	x 2	22.5	\$530.38	\$617.78
	x 3	26.5	\$530.38	\$625.64
	x 4	30.5	\$530.38	\$635.47
6 x 6	x 3	37.0	\$685.09	\$815.05
	x 4	40.0	\$685.09	\$820.93
	x 5	45.0	\$685.09	\$830.02
8 x 8	x 4	59.6	\$988.99	\$1,193.81
	x 5	68.0	\$988.99	\$1,204.53
	x 6	75.0	\$988.99	\$1,219.41
10 x 10	x 4	83.0	\$1,123.72	\$1,404.72
	x 5	100.0	\$1,232.70	\$1,498.45
	x 6	105.0	\$1,232.70	\$1,498.45
	x 8	116.0	\$1,255.61	\$1,594.59



Grooved End Butterfly Valve Series 7700



Valve with Epoxy Coated Body (Grade "E" or Grade "T" Disc)



For listing/approval details contact your Gruklok Representative.

Nominal Size (Inches)	10 Position Handle with Latch-Lock Memory Stop	(AE7721-3-"E") (AE7711-3-"T")	(AE7722-3-"E") (AE7712-3-"T")	Gear Operator with Chainwheel
2	\$357.47		\$654.17	+
2½	\$440.33		\$742.61	+
3	\$459.11		\$755.97	+
4	\$544.25		\$826.65	+
5	\$964.69		\$1,247.17	+
6	\$1,040.06		\$1,322.60	+
8	\$1,311.98		\$1,594.38	+
10	\$2,073.23		\$2,334.57	+
12	\$2,567.28		\$3,160.70	+

+ Priced on Application. Contact your Anvil Representative for Engineering Assistance.

Valve with Nylon Coated Body (Grade "E" or Grade "T" Disc)

(AN7721-3-"E")

(AN7711-3-"T")

Nominal Size (Inches)	10 Position Handle with Latch-Lock Memory Stop	(AN7722-3-"E") (AN7712-3-"T")	Gear Operator with Chainwheel
2	\$340.52	\$623.00	+
2½	\$419.49	\$701.60	+
3	\$437.54	\$720.09	+
4	\$523.34	\$805.74	+
5	\$933.27	\$1,215.60	+
6	\$1,008.58	\$1,290.48	+
8	\$1,270.05	\$1,552.54	+
10	\$1,916.40	\$2,224.18	+
12	\$2,159.02	\$2,466.73	+

+ Priced on Application. Contact your Anvil Representative for Engineering Assistance.

Valve with Epoxy Coated Body (Grade "O" Disc)



For listing/approval details contact your Gruklok Representative.

Nominal Size (Inches)	10 Position Handle with Latch-Lock Memory Stop	(AE7731-3)	(AE7732-3)	Gear Operator with Chainwheel
2	\$505.13		\$801.77	+
2½	\$628.64		\$925.35	+
3	\$693.97		\$968.57	+
4	\$757.66		\$1,040.06	+
5	\$1,217.89		\$1,500.21	+
6	\$1,318.20		\$1,600.68	+
8	\$1,857.90		\$2,140.15	+
10	\$3,022.44		\$3,284.07	+
12	\$3,639.77		\$3,901.19	+

Available Silicone Free (price and availability upon request)

+ Priced on Application. Contact your Anvil Representative for Engineering Assistance.

Valve with Nylon Coated Body (Grade "O" Disc)

(AN7731-3)

Nominal Size (Inches)	10 Position Handle with Latch-Lock Memory Stop	(AN7732-3)	Gear Operator with Chainwheel
2	\$481.06	\$763.61	+
2½	\$598.70	\$881.33	+
3	\$638.63	\$922.42	+
4	\$736.82	\$1,019.07	+
5	\$1,186.39	\$1,468.88	+
6	\$1,286.73	\$1,569.27	+
8	\$1,815.93	\$2,098.40	+
10	\$2,865.89	\$3,127.59	+
12	\$3,232.47	\$3,493.44	+

+ Priced on Application. Contact your Anvil Representative for Engineering Assistance.

SERIES 7700 BUTTERFLY VALVES (Ordering Information)

Order by Figure Number

List Exact Size 2" thru 12" **8"**

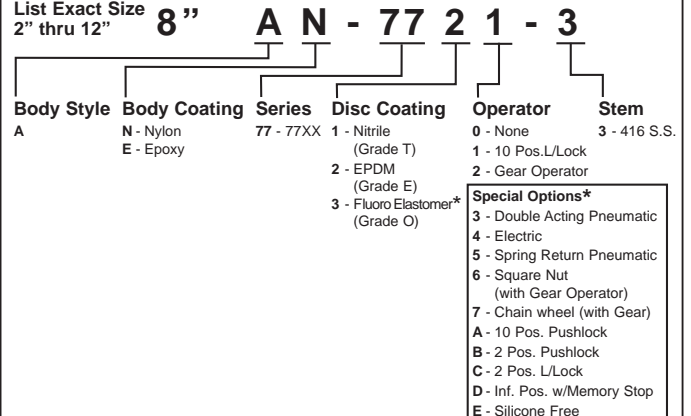

*Special Disc Coatings & Special Options - Call an Anvil Representative for pricing and availability.

Note: For operator safety, levers on 8" and larger valves are limited to applications with a 25 PSI maximum pressure for liquid media.



Gruvlok® Butterfly Valve Fig. 8000GR

Grooved-End Couplings

Fittings

Valves and Accessories

Spare Parts

Plain-End

Copper Method

Tools

SERIES 8000GR BUTTERFLY VALVES (Ordering Information)

SIZE: 14" - 24"

18" G C - 8 2 8 2 - 6

Valve Size	Body Style	Body Material	Series	Seat Material	Disc Material	Operator	Stem
14" - 24"	G - Grooved-End	C - Cast iron	8 - 8000	1 - Nitrile 2 - EPDM	0 - Nickel-Plated ductile iron 7 - 316 S.S. 8 - Bronze (Al-Brz)	0 - None 2 - Gear Operator 3 - Pneumatic 4 - Electric 5 - Spring Return Pneumatic 6 - Square Nut (with Gear Operator) 7 - Chain Wheel (with Gear)	6 - 416 S.S. with RTFE Bearing 7 - 316 S.S. with RTFE Bearing

*Contact your Anvil Representative for Engineering Assistance



Nominal Size (Inches)	Aprx. Weight (Lbs.)		With Gear Operator
	Valve only	w/ Gear Operator	
14	354	378	\$6,563.87
16	428	452	\$9,490.75
18	524	548	\$11,675.75
20	704	728	\$14,370.06
24	1027	1097	\$19,244.97

Gruvlok® Ball Valves Fig. 7500

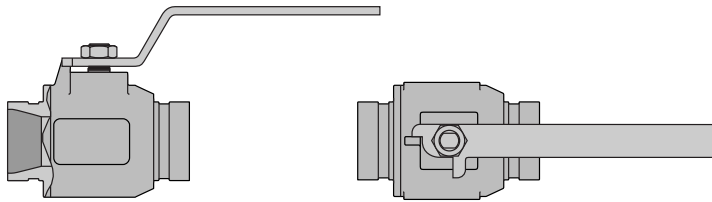

Fig. 7500 Sizes 2" - 4"

GRUVLOK BALL VALVES SERIES 7500 (Ordering Information)

SIZE: 2" - 4"

4" G I - 75 1 2 - 2

Valve Size	Configuration	Body/End	Series	Ball/Stem	Seat/Seals	Operator
2" - 4"	G - 2 way Grooved End	I - Ductile Iron ASTM A395	75 - 7500	1 - Chrome Plated Carbon Steel 2 - 316 Stainless	2 - RPTFE/Viton	1 - 2 pos. handle 2 - 2 pos. locking handle 3 - Bare Stem

Special Requirements
X-Write on Order

Nominal Size (Inches)	Aprx. Weight Each (Lbs.)	with Two Position Handle or with Two Position Locking Handle
-----------------------	--------------------------	--

DI Body with Carbon Steel Trim (Example: GI 7512-2)

2	8.0	\$263.10
3	18.0	\$854.68
4	38.0	\$1,319.53

DI Body with Stainless Steel Trim (Example: GI 7522-2)

2	8.0	\$388.52
3	18.0	\$1,198.23
4	38.0	\$2,032.94

Note: Stainless Steel available. See Stainless Steel Price Sheet for listing price.

Bronze Grooved End Ball Valve, Fig. 7500B



Fig. 7500B

Fig. 7500B with Stem Extension

Nominal Size (Inches)	Aprx. Weight Each (Lbs.)	Price Each
1½	3.5	\$273.96
2	4.5	\$380.52
2½	8.0	\$529.12
3	13.0	\$596.20
4	22.0	\$705.11

Stem Extension Kits

1½	0.3	\$11.23
2	0.4	\$13.95
2½ - 4	0.5	\$17.40

Grooved end Butterfly Valve, Series 7600

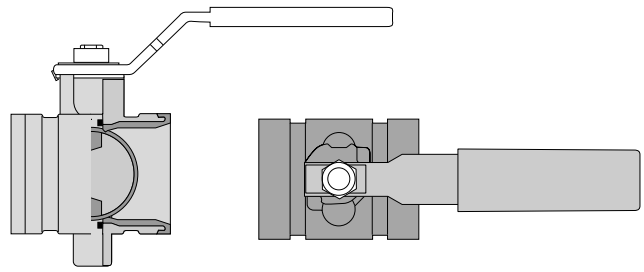

Two Position Detent Handle

Nominal Pipe Size (Inches)	Aprx. Weight Each (Lbs.)	Price Each
2	3.3	\$297.15
2½	6.4	\$376.86
3	6.8	\$426.24
4	12.1	\$468.96
5	26.1	\$895.35
6	32.5	\$947.30

Epoxy coated body with EPDM Grade "E" or Nitrile Grade "T".

Gruvlok® Circuit Balancing Valves Sweat Four Turn Fig. GBV-S

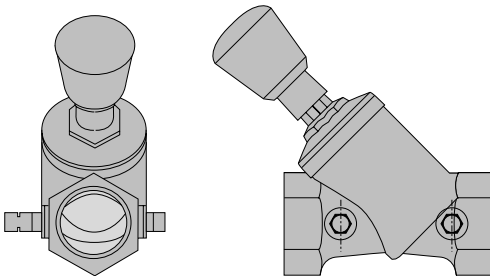

Item	Aprx. Weight Each (Lbs.)	List Price
½	2.0	\$55.78
¾	2.0	\$59.00
1	3.0	\$77.06
1¼	4.0	\$116.69
1½	4.5	\$134.45
2	5.5	\$202.19

Gruvlok® Circuit Balancing Valves Threaded Four Turn Fig. GBV-T

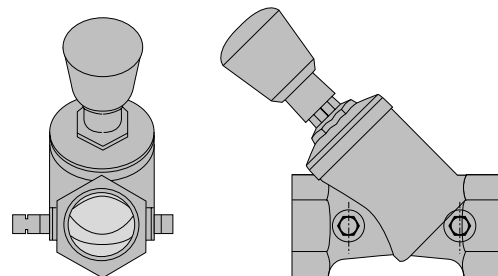

Item	Aprx. Weight Each (Lbs.)	List Price
½	2.0	\$54.09
¾	2.0	\$59.74
1	3.0	\$78.01
1¼	4.0	\$117.78
1½	4.5	\$136.79
2	5.5	\$204.53

Flanged valve prices available through your Anvil Representative.

**Gruvlok® Circuit Balancing Valves
Grooved End Straight GBV-G &
End Angle Fig. GBV-A**

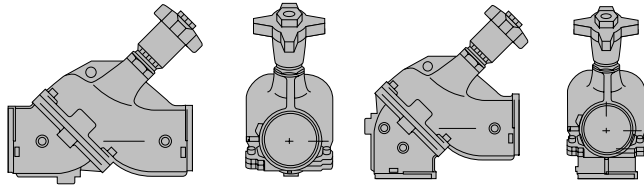

Item	Aprx. Weight Each (Lbs.)	List Price
2½	25.0	\$446.72
3	28.0	\$696.98
4	41.0	\$964.10
5	90.0	\$1,746.50
6	130.0	\$2,339.48
8	310.0	\$4,986.38
10	460.0	\$6,542.52
12	870.0	\$14,219.10

**Gruvlok® End Check Valve,
Fig. 7800**

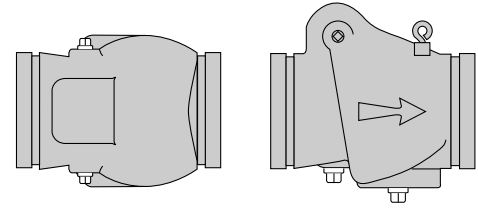

Nominal Pipe Size (Inches)	Aprx. Weight Each (Lbs.)	Price Each
2	7.5	\$337.74
2½	10.5	\$337.74
3	11.5	\$399.10
4	13.5	\$421.55
5	19.0	\$702.03
6	33.5	\$832.52
8	59.0	\$1,137.74
10	130.0	\$3,292.50
12	183.0	\$3,902.21

The series 7800 Gruvlok Check Valve come standard with cast ductile iron body, stainless steel seat ring, hinge pin and closure spring. Clapper seat facing of grade "E" EPDM or grade "T" (buna) Elastomer. NPT plugs in the body accommodate valve drain-down.

Silent Check Valve Fig. 400G

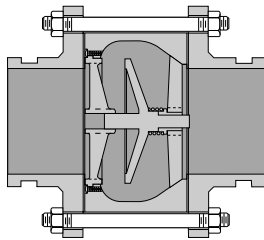

Nominal Pipe Size (Inches)	Aprx. Weight Each (Lbs.)	Price Each
2	12.0	\$526.65
2½	15.0	\$639.94
3	20.0	\$719.94
4	36.0	\$953.25
5	50.0	\$1,319.90
6	68.0	\$1,593.19
8	140.0	\$2,719.78
10	198.0	\$4,133.02

Grooved-End
Couplings

Fittings

Valves and
Accessories

Spare Parts

Plain-End

Copper Method

Tools

Suction Diffuser Fig. 7250

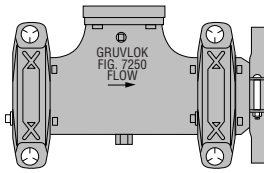

2 1/2" x 2 1/2"
thru 10" x 8"

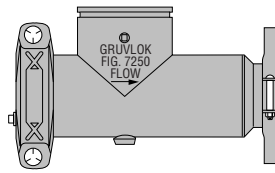

10" x 10"
thru 16" x 14"

Nominal Pipe Size (Inches)	Grooved End Inlet x Flange Adapter Outlet	Aprx. Weight Each (Lbs.)	Price Each Painted
2 1/2	x 2 1/2 2 1/2 x 2 1/2	36.0	\$1,593.63
3	x 2 3 x 2	36.0	\$1,691.18
	x 2 1/2 3 x 2 1/2	36.0	\$1,215.53
	x 3 3 x 3	37.0	\$1,231.68
4	x 2 4 x 2	38.0	\$1,265.66
	x 2 1/2 4 x 2 1/2	38.0	\$1,335.67
	x 3 4 x 3	38.0	\$1,440.98
	x 4 4 x 4	72.0	\$1,668.71
5	x 4 5 x 4	74.0	\$1,860.18
	x 5 5 x 5	75.0	\$1,954.64
6	x 3 6 x 3	72.0	\$1,964.83
	x 4 6 x 4	72.0	\$1,983.40
	x 5 6 x 5	74.0	\$2,372.51
	x 6 6 x 6	133.0	\$2,463.51
8	x 5* 8 x 5	118.0	\$2,527.21
	x 6 8 x 6	118.0	\$2,664.89
	x 8 8 x 8	190.0	\$4,585.91
10	x 6 10 x 6	100.0	\$4,761.53
	x 8 10 x 8	203.0	\$5,174.54
	x 10* 10 x 10	192.0	\$6,235.46
12	x 8 12 x 8	196.0	\$6,529.08
	x 10* 12 x 10	196.0	\$7,380.83
	x 12* 12 x 12	382.0	\$10,266.18
14	x 10* 14 x 10	382.0	\$9,554.46
	x 12* 14 x 12	382.0	\$10,672.91
	x 14* 14 x 14	467.0	\$12,960.85
16	x 14* 16 x 14	467.0	\$13,339.98

*Fabricated

The Fig. 7250 Gruvlok Suction Diffuser comes standard with type 304 stainless steel diffuser and pre-filter screen, ductile or malleable iron access cap and coupling with Grade "E" EPDM gasket, and plated bolts and nuts. NPT taps and plugs are provided in the body to accommodate drain and gauges.

Groove x Groove Connectors • Class 150

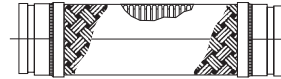

Pipe Size (Inches)	AnvilFlex AF-21-GG		Anvil SF-21-GG		Price Each
	Product Number	End to End (Inches)	Product Number	End to End (Inches)	
2	AF0390232007	12	0390232007	12	\$158.07
2 1/2	AF0390232007	12	0390232015	14	\$191.32
3	AF0390232031	12	0390232023	14	\$218.55
4	AF0390232114	14	0390232049	16	\$281.29
5	AF0390232122	16	0390232056	17	\$440.11
6	AF0390232130	16	0390232064	18	\$485.96
8	AF0390232148	16	0390232072	20	\$929.39
10	AF0390232155	20	0390232080	24	\$1,606.70
12	AF0390232163	20	0390232098	25	\$2,268.51

Shaded product have different end to end dimensions.

Groove x Flange Connectors • Class 150

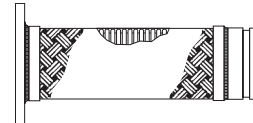

Pipe Size (Inches)	AnvilFlex AF-21-GF		Anvil SF-21-GF		Price Each
	Product Number	End to End (Inches)	Product Number	End to End (Inches)	
2	AF0390232197	12	0390232197	12	\$168.28
2 1/2	AF0390232213	12	0390232213	12	\$209.45
3	AF0390232171	12	0390232221	13	\$250.11
4	AF0390232189	12	0390232239	13	\$292.31
5	AF0390232247	14	0390232247	14	\$464.63
6	AF0390232254	14	0390232254	14	\$500.88
8	AF0390232262	15	0390232262	15	\$915.22
10	AF0390232270	16	0390232270	16	\$1,620.93
12	AF0390232288	17	0390232288	17	\$2,278.49

Shaded product have different end to end dimensions.

Flange x Flange Connectors • Class 150

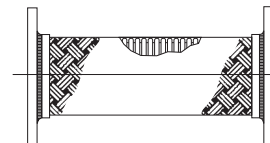

Pipe Size (Inches)	AnvilFlex AF-21-FF		Anvil SF-21-FF		Price Each
	Product Number	End to End (Inches)	Product Number	End to End (Inches)	
2	AF0390232387	9	0390232387	9	\$174.22
2 1/2	AF0390232395	9	0390232395	9	\$213.64
3	AF0390232403	9	0390232403	9	\$246.72
4	AF0390232429	9	0390232429	9	\$299.79
5	AF0390232437	11	0390232437	11	\$460.43
6	AF0390232445	11	0390232445	11	\$524.50
8	AF0390232452	12	0390232452	12	\$1,099.66
10	AF0390232460	13	0390232460	13	\$1,615.06
12	AF0390232478	14	0390232478	14	\$2,318.35

Reducing and combination flex connectors available. Contact your Anvil Rep.

Gruvlok Air Vent GAV-15 & GAV-30

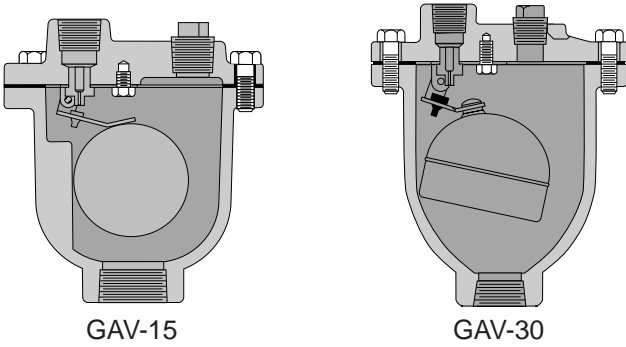

Size (Inches)	Part Number	Aprx. Weight Each (Lbs.)	Inlet Size (Inches)	Price Each
1/2	GAV-15	5.5	1/2	\$184.72
3/4	GAV-15	5.5	3/4	\$184.72
1	GAV-15	5.5	1	\$184.72
1/2	GAV-30	8.0	1/2	\$279.98
3/4	GAV-30	8.0	3/4	\$279.98

Grooved-End Strainer Fig. 7260

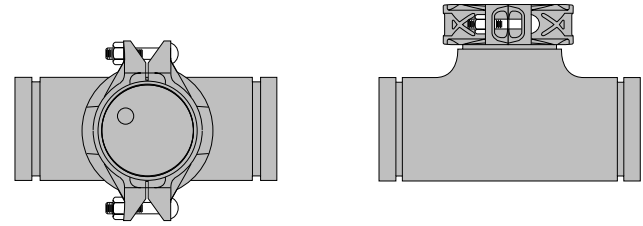

Nominal Pipe Size (Inches)	Aprx. Weight Each (Lbs.)	Price Each	
		Painted	Galvanized
2	6.0	\$753.04	\$823.94
2 1/2	8.0	\$791.06	\$870.39
3	13.0	\$888.51	\$992.66
4	19.0	\$1,005.50	\$1,150.14
5	30.0	\$1,456.62	\$1,627.92
6	45.0	\$1,580.73	\$1,799.78
8	79.0	\$2,424.18	\$2,777.32
10	133.0	\$3,560.45	\$4,100.88
12	187.0	\$4,583.27	\$5,266.65
14	272.0	\$16,335.99	POA
16	350.0	\$20,303.23	POA
18	400.0	\$26,704.71	POA

The Fig. 7260 Gruvlok Strainer comes standard with type 304 stainless steel strainer screen, ductile iron access cap and coupling with Grade "E" EPDM gasket, and plated bolts and nuts. An NPT tap and plugs are provided in the access cap to accommodate a drain or blow-down valve. Additional sizes available, contact your Anvil Rep. for engineering assistance.

Grooved-End "WYE" Strainer Fig. 768G

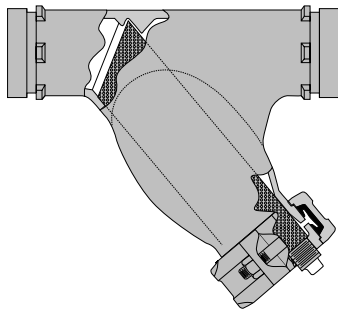

Nominal Pipe Size (Inches)	Aprx. Weight Each (Lbs.)	Price Each Painted
2	10.0	\$762.44
2 1/2	14.0	\$800.97
3	20.0	\$899.52
4	32.0	\$1,018.28
6	72.0	\$1,601.18
8	125.0	\$2,454.55
10	205.0	\$3,945.88
12	280.0	\$6,892.94

Gruvlok Tri-Service Valve Fig. FTV-S (Straight) or Fig. FTV-A (Angle body)

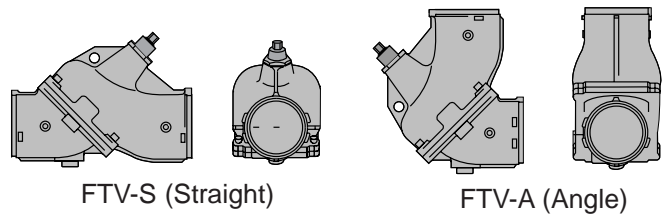

Nominal Pipe Size (Inches)	Aprx. Weight Each (Lbs.)	Price Each
2	23.5	\$1,549.82
2 1/2	24.0	\$1,570.65
3	33.0	\$1,708.41
4	84.0	\$2,342.19
5	81.0	\$2,563.47
6	156.0	\$3,837.12
8	300.0	\$5,697.08
10	392.0	\$9,410.02
12	496.0	\$13,205.76

Mechanical Tee Product Fig. 7045 Clamp-T® Female Threaded Outlet



For listing/approval details contact your Gruvlok Representative.

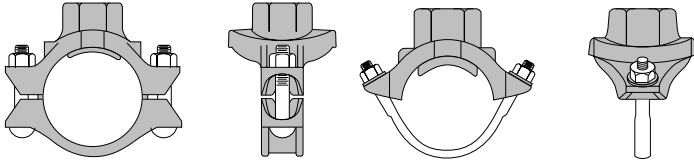

Fig. 7045 (U-Bolt)

Nominal Pipe Size Run (Inches)	Outlet (Inches)	Aprx. Weight Each (Lbs.)	Complete Clamp-T Female Threaded Outlet		*Bolt and Nut Size (Inches)
			E or T Gasket Price Each	Galv.	
2	x 1/2**	3.0	\$33.75	\$40.50	1/2 U-Bolt
	x 3/4**	2.9	\$33.75	\$40.50	1/2 U-Bolt
	x 1**	2.9	\$33.75	\$40.50	1/2 U-Bolt
	x 1 1/4**	4.0	\$38.97	\$46.17	1/2 U-Bolt
	x 1 1/2**	3.9	\$38.97	\$46.17	1/2 U-Bolt
2 1/2	x 1/2**	3.0	\$33.75	\$40.50	1/2 U-Bolt
	x 3/4**	2.9	\$33.75	\$40.50	1/2 U-Bolt
	x 1**	2.9	\$33.75	\$40.50	1/2 U-Bolt
	x 1 1/4**	3.4	\$47.63	\$55.84	1/2 U-Bolt
	x 1 1/2**	3.4	\$47.63	\$55.84	1/2 U-Bolt
3	x 1/2**	2.8	\$38.83	\$45.13	1/2 U-Bolt
	x 3/4**	2.7	\$38.83	\$45.13	1/2 U-Bolt
	x 1**	2.7	\$38.83	\$45.13	1/2 U-Bolt
	x 1 1/4	3.4	\$49.91	\$59.74	1/2 x 2 3/4
	x 1 1/2	4.4	\$49.91	\$59.74	1/2 x 2 3/4
4	x 2	4.6	\$57.61	\$68.47	1/2 x 2 3/4
	x 1/2**	2.9	\$49.46	\$56.21	1/2 U-Bolt
	x 3/4**	2.8	\$49.46	\$56.21	1/2 U-Bolt
	x 1**	2.7	\$49.46	\$56.21	1/2 U-Bolt
	x 1 1/4	4.5	\$58.20	\$65.24	1/2 x 2 3/4
5	x 1 1/2	4.6	\$59.74	\$72.95	1/2 x 2 3/4
	x 2	5.2	\$59.74	\$72.95	1/2 x 2 3/4
	x 2 1/2	5.2	\$63.05	\$78.67	1/2 x 2 3/4
	x 3	6.5	\$67.66	\$83.01	1/2 x 3 1/2
	x 1 1/4	5.4	\$0.00	\$87.05	5/8 x 3 1/4
6	x 1 1/2	5.5	\$74.27	\$90.12	5/8 x 3 1/4
	x 2	5.7	\$74.27	\$90.20	5/8 x 3 1/4
	x 2 1/2	7.0	\$78.60	\$95.48	5/8 x 3 1/4
	x 3	8.7	\$83.88	\$102.88	5/8 x 3 1/4
	x 1 1/4	7.8	\$61.07	\$90.35	5/8 x 4 1/4
8	x 1 1/2	7.8	\$76.11	\$93.49	5/8 x 4 1/4
	x 2	7.8	\$76.11	\$93.49	5/8 x 4 1/4
	x 2 1/2	8.4	\$82.33	\$101.28	5/8 x 4 1/4
	x 3	9.6	\$87.54	\$107.58	5/8 x 4 1/4
	x 4	10.5	\$96.94	\$120.50	5/8 x 4 1/4
8	x 2***	10.9	\$134.60	\$161.82	3/4 x 4 1/4
	x 2 1/2	11.1	\$134.60	\$161.82	3/4 x 4 1/2
	x 3	13.0	\$142.01	\$171.66	3/4 x 4 1/2
	x 4	16.2	\$146.34	\$180.31	3/4 x 4 1/2

Clamp T's are available with grooved or female threaded outlet with Grade E or Grade T gasket. Weights are approximate and subject to change.

*All bolts and nuts are of track head design and are zinc plated conforming to physical properties of ASTM B-633.

** Clamp-T supplied with U-Bolt lower housing.

*** Note: 8 x 2 is actually 8 x 2 1/2 bushed down.

Mechanical Tee Product Fig. 7046 Clamp-T® Grooved Outlet



For listing/approval details contact your Gruvlok Representative.

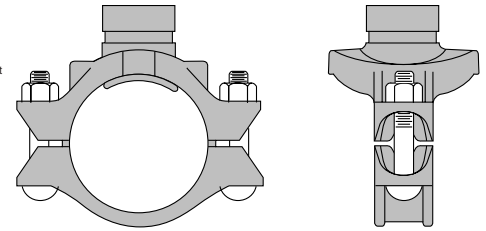

Nominal Pipe Size Run (Inches)	Outlet (Inches)	Aprx. Weight Each (Lbs.)	Complete Clamp-T Grooved Branch*		*Bolt and Nut Size (Inches)
			E or T Gasket Price Each	Galv.	
2 1/2**	x 1 1/4	3.4	\$47.63	\$55.84	1/2 U-Bolt
	x 1 1/2	3.4	\$47.63	\$55.84	1/2 U-Bolt
3	x 1 1/4	3.4	\$49.91	\$59.74	1/2 x 2 3/4
	x 1 1/2	4.4	\$49.91	\$59.74	1/2 x 2 3/4
4	x 2	4.6	\$57.61	\$68.47	1/2 x 2 3/4
	x 1 1/4	4.2	\$58.20	\$65.24	1/2 x 2 3/4
	x 1 1/2	4.3	\$60.63	\$72.95	1/2 x 2 3/4
	x 2	4.6	\$60.63	\$73.31	1/2 x 2 3/4
	x 2 1/2	5.0	\$63.05	\$78.67	1/2 x 2 3/4
5	x 3	5.6	\$67.66	\$83.01	1/2 x 3 1/2
	x 1 1/4	5.0	\$70.01	\$87.05	5/8 x 3 1/4
	x 1 1/2	5.6	\$74.27	\$90.12	5/8 x 3 1/4
	x 2	5.5	\$74.27	\$90.12	5/8 x 3 1/4
6	x 2 1/2	5.8	\$78.60	\$95.48	5/8 x 3 1/4
	x 3	7.1	\$83.88	\$102.88	5/8 x 3 1/4
	x 1 1/4	7.2	POA	POA	5/8 x 4 1/4
	x 1 1/2	7.2	\$76.11	\$93.49	5/8 x 4 1/4
8	x 2	7.8	\$76.11	\$93.49	5/8 x 4 1/4
	x 2 1/2	7.6	\$83.96	\$101.28	5/8 x 4 1/4
	x 3	8.0	\$87.54	\$107.58	5/8 x 4 1/4
	x 4	10.4	\$96.94	\$120.50	5/8 x 4 1/4
8	x 2	10.4	\$124.10	\$149.28	3/4 x 4 1/4
	x 2 1/2	10.6	\$134.60	\$161.82	3/4 x 4 1/2
	x 3	11.5	\$142.01	\$171.66	3/4 x 4 1/2
	x 4	16.2	\$146.34	\$180.31	3/4 x 4 1/2

Clamp T's are available with grooved Grade E or Grade T gasket. Weights are approximate and subject to change.

*All bolts and nuts are of track head design and are zinc plated conforming to physical properties of ASTM B-633.

** Clamp-T supplied with U-Bolt lower housing.

Mechanical Tee Product

Clamp-T® Cross Fig. 7047, Fig. 7048 and Fig. 7049



APPROVED
For listing/approval details contact
your Gruvlok Representative.

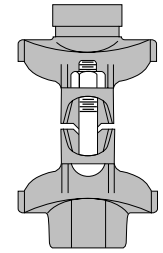
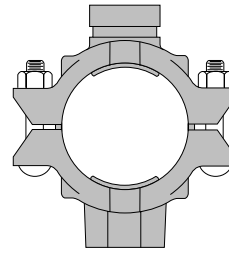
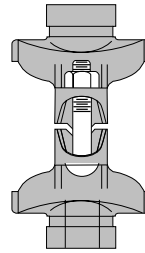
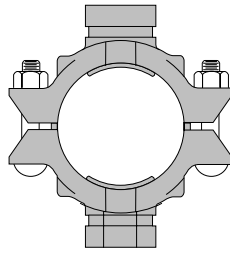
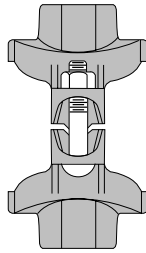
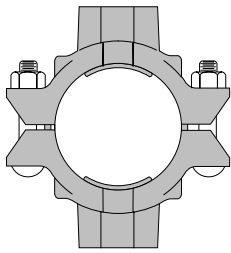

Fig. 7047 – Thread x Thread

Fig. 7048 – Groove x Groove

Fig. 7049 – Groove x Thread

Nominal Pipe Size Run (Inches)	Outlet (Inches)	Complete Clamp-T Cross with "E" or "T" Gasket Price Each	
		Painted	Galv.
		A	B
2½	1 x 1*	\$53.79	\$66.13
	1 x 1¼*	\$74.70	\$91.89
	1 x 1½*	\$74.70	\$91.89
	1¼ x 1¼*	\$74.70	\$91.89
	1½ x 1¼*	\$74.70	\$91.89
	1½ x 1½*	\$74.70	\$91.89
3	1 x 1*	\$60.78	\$74.63
	1 x 1¼	\$74.70	\$89.38
	1 x 1½	\$74.70	\$89.38
	1 x 2	\$86.38	\$102.67
	1¼ x 1¼	\$74.70	\$89.38
	1½ x 1¼	\$74.70	\$89.38
	1½ x 1½	\$74.70	\$89.38
	2 x 1¼	\$86.38	\$102.67
	2 x 1½	\$86.38	\$102.67
	2 x 2	\$86.38	\$102.67
4	1 x 1	\$75.15	\$92.39
	1 x 1¼	\$87.05	\$107.07
	1 x 1½	\$90.93	\$111.69
	1 x 2	\$97.25	\$120.29
	1¼ x 1¼	\$87.05	\$109.13
	1½ x 1¼	\$90.93	\$109.13
	1½ x 1½	\$90.93	\$109.13
	2 x 1¼	\$90.93	\$109.13
	2 x 1½	\$97.15	\$109.87
	2 x 2	\$97.15	\$109.87
	2½ x 2½	\$94.32	\$117.78
	3 x 3	\$101.65	\$124.83

Nominal Pipe Size Run (Inches)	Outlet (Inches)	Complete Clamp-T Cross with "E" or "T" Gasket Price Each	
		Painted	Galv.
		A	B
5	1½ x 1½	\$111.32	\$135.19
	2 x 1½	\$111.32	\$135.19
	2 x 2	\$111.32	\$135.19
	2½ x 1½	\$117.64	\$143.26
	2½ x 2	\$117.64	\$143.26
	2½ x 2½	\$117.64	\$143.26
	3 x 1½	\$125.79	\$154.34
	3 x 2	\$125.79	\$154.34
6	3 x 2½	\$125.79	\$154.34
	3 x 3	\$125.79	\$154.34
	1½ x 1½	\$114.05	\$140.17
	2 x 1½	\$114.05	\$140.17
	2 x 2	\$114.05	\$140.17
	2½ x 2½	\$123.37	\$151.55
	3 x 2½	\$131.37	\$161.16
	3 x 3	\$131.37	\$161.16
8	4 x 2½	\$145.17	\$180.61
	4 x 3	\$145.17	\$180.61
	4 x 4	\$145.17	\$180.61
	2½ x 2½	\$201.75	\$242.69
	3 x 2½	\$212.75	\$257.53
	3 x 3	\$212.75	\$257.53
	4 x 2½	\$218.85	\$270.51
	4 x 3	\$218.85	\$270.51
4 x 4	\$218.85	\$270.51	

*Available with Female Threaded outlet only.
Always specify gasket grade when ordering.

Grooved-End
Couplings

Fittings

Valves and
Accessories

Spare Parts

Plain-End

Copper Method

Tools

Flange Nipples, Fig. 7084 (150 lb) & Fig. 7085 (300 lb)

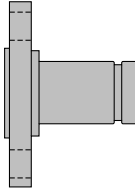

Fig. 7084 (150 lb)
(Price Each)

Fig. 7085 (300 lb)
(Price Each)

Size (Inches)	End to End (Inches)	Fig. 7084 (150 lb)		Fig. 7085 (300 lb)	
		Painted	Galvanized	Painted	Galvanized
1	x 3	\$150.01	\$176.21	\$172.76	\$205.85
1¼	x 4	\$150.01	\$176.21	\$172.76	\$205.85
1½	x 4	\$150.01	\$176.21	\$172.76	\$205.85
2	x 4	\$150.01	\$176.21	\$172.76	\$205.85
2½	x 4	\$177.45	\$176.21	\$172.76	\$205.85
3	x 4	\$191.90	\$225.52	\$256.28	\$308.67
3½	x 4	\$207.48	\$245.99	POA	POA
4	x 6	\$299.21	\$413.48	\$351.61	\$366.35
5	x 6	\$326.81	\$395.28	\$463.29	\$556.01
6	x 6	\$372.96	\$448.77	\$495.29	\$613.60
8	x 6	\$514.82	\$623.21	\$730.44	\$901.43
10	x 8	\$839.93	\$1,004.25	\$1,306.46	\$1,446.70
12	x 8	\$1,319.38	\$1,442.45	\$1,591.66	\$1,763.90
14	x 8	\$2,289.03	POA	POA	POA
16	x 8	\$3,220.81	POA	POA	POA
18	x 8	POA	POA	POA	POA
20	x 8	POA	POA	POA	POA
24	x 8	POA	POA	POA	POA

Flange by concentric reducer configurations also available.
Contact your Anvil Rep. for more dimensions and weights or additional details.

Spare Parts

Flange Parts for Gruvlok Flange Fig. 7012

Flange Size (in.)	Qty. Per Set	Mating Flange Bolt and Nut		Seal Ring Fig. 7012
		Size (in.)	Price per Set Plated	
2	4	5/8 x 2¾	\$27.74	\$37.80
2½	4	5/8 x 2¾	\$27.74	\$39.41
3	4	5/8 x 2¾	\$27.74	\$46.53
4	8	5/8 x 2¾	\$55.33	\$54.39
5	8	¾ x 2⅞	\$59.51	\$66.35
6	8	¾ x 3⅛	\$59.51	\$75.31
8	8	¾ x 3¼	\$59.51	\$95.63
10	12	7/8 x 3½	\$135.04	\$133.20
12	12	7/8 x 3¾	\$135.04	\$172.31
14	12	1 x 4¼	\$224.93	\$187.94
16	16	1 x 4¼	\$300.31	\$334.79
18	16	1½ x 4¾	\$451.27	\$356.74
20	20	1½ x 4¾	\$577.50	\$409.73
24	20	1¼ x 5½	\$719.36	\$687.94

Note: items listed are non-cancellable and non-returnable

Flange Parts for Gruvlok Flange Fig. 7013

Flange Size (in.)	Qty. Per Set	Mating Flange Bolt and Nut		Seal Ring Fig. 7013
		Size (in.)	Price per Set Plated	
2	8	5/8 x 3	\$27.74	\$37.80
2½	8	¾ x 3¼	\$27.74	\$39.41
3	8	¾ x 3½	\$27.74	\$46.53
4	8	¾ x 3¾	\$55.33	\$54.39
5	8	¾ x 4½	\$59.51	\$66.35
6	12	¾ x 4½	\$59.51	\$75.31
8	12	7/8 x 4¾	\$59.51	\$95.63
10	16	1 x 5	\$135.04	\$133.20
12	16	1½ x 5¾	\$135.04	\$172.31

Grooved-End Couplings

Flange Gaskets for Fig. 7012 & 7013 Gruvlok Flanges

Flange Size (in.)	Standard Gaskets Grade "E" or "T" gasket only
2	\$10.28
2½	\$12.04
3	\$13.44
4	\$17.53
5	\$21.65
6	\$24.81
8	\$33.69
10	\$43.59
12	\$50.64
14	\$67.08
16	\$75.06
18	\$109.87
20	\$118.89
24	\$131.95

Note: items listed are non-cancellable and non-returnable.

Fittings

Valves and Accessories

Spare Parts

Plain-End

Copper Method

Tools

Standard Gaskets for Fig. 7005 & 7305 Couplings

Nominal Size (in.)	Standard Gaskets Grade "E" or "T" gasket only
2	\$17.32
2½	\$18.35
3	\$20.10
4	\$30.30
5	\$35.74
6	\$43.52
8	\$57.69
10	\$73.83
12	\$90.35

Fig. 7004EG Gasket (Use with 7004EG Housing)

Nominal Size (in.)	EG Gasket gasket only
2	\$23.78
2½	\$29.87
3	\$33.02
4	\$41.89
6	\$61.21
8	\$82.79
10	\$135.63
12	\$154.34

Note: items listed are non-cancellable and non-returnable.

Reducing Coupling Fig. 7010 Loose Gasket

Nominal Pipe Size (in.)	Spare Parts "E" or "T" gasket only
2 x 1½	\$12.32
2½ x 2	\$16.36
3 x 2	\$19.31
3 x 2½	\$19.31
4 x 2	\$22.38
4 x 2½	\$22.61
4 x 3	\$23.78
5 x 4	\$27.82
6 x 4	\$31.79
6 x 5	\$34.87
8 x 6	\$38.60

Plated Trackhead Bolts and Nuts for Couplings

Bolt and Nut Size (in.)	Price Each
⅜ x 2¼	\$5.20
⅜ x 2½	\$7.85
½ x 2¾	\$5.65
½ x 3	\$5.58
½ x 3½	\$8.44
⅝ x 2¾	\$6.78
⅝ x 3¼	\$7.20
⅝ x 3½	\$7.56
⅝ x 4¼	\$9.84
¾ x 4½	\$8.22
7⁄8 x 5	\$15.55
7⁄8 x 5½	\$18.56
7⁄8 x 6	\$13.80
1 x 5½	\$20.48
1 x 6	\$20.48
1 x 6½	\$21.43
1½ x 5½	\$28.12

Note: items listed are non-cancellable and non-returnable.

Standard Gaskets

Nominal Size (Inches)	Grade "E" EPDM or Grade "T" Nitrile	Flush Seal Grade "E"	Grade "L" Silicone	Grade "O" Fluoroelastomer
1	\$11.95	\$24.08	\$45.79	\$153.31
1¼	\$12.32	\$25.39	\$66.50	\$146.62
1½	\$13.29	\$25.69	\$69.50	\$155.36
2	\$13.29	\$26.06	\$42.42	\$126.30
2½	\$16.22	\$31.21	\$49.31	\$142.89
3	\$17.68	\$31.21	\$53.36	\$158.07
4	\$22.46	\$43.59	\$77.86	\$260.31
5	\$29.28	\$78.60	\$154.77	\$279.17
6	\$31.79	\$79.85	\$169.60	\$342.14
8	\$43.67	\$83.30	\$180.97	\$392.05
10	\$55.84	\$107.29	\$236.31	\$510.63
12	\$65.02	\$128.36	\$278.95	\$757.29
14	\$89.91	\$134.01	-	-
16	\$124.47	-	-	-
18	\$150.31	-	-	-
20	\$231.25	-	-	-
22	POA	-	-	-
24	\$321.30	-	-	-

Note: items listed are non-cancellable and non-returnable.

Clamp-T® Female Threaded Outlet Fig. 7045 (Gasket only)

Nominal Pipe Size	Outlet	"E" or "T" Gasket Gasket Only Price each
Run (Inches)	(Inches)	
2	x 1/2	\$5.05
	x 3/4	\$5.05
	x 1	\$5.05
	x 1 1/4	\$6.32
	x 1 1/2	\$6.32
2 1/2	x 1/2	\$5.05
	x 3/4	\$5.05
	x 1	\$5.05
	x 1 1/4	\$6.32
	x 1 1/2	\$6.32
3	x 1/2	\$5.05
	x 3/4	\$5.05
	x 1	\$5.05
	x 1 1/4	\$6.32
	x 1 1/2	\$6.32
4	x 1/2	\$5.05
	x 3/4	\$5.05
	x 1	\$5.05
	x 1 1/4	\$6.32
	x 1 1/2	\$6.32
	x 2	\$6.39
	x 2 1/2	\$7.42
	x 3	\$8.07

Nominal Pipe Size	Outlet	"E" or "T" Gasket Gasket Only Price each
Run (Inches)	(Inches)	
5	x 1 1/4	\$6.32
	x 1 1/2	\$6.32
	x 2	\$6.39
	x 2 1/2	\$7.42
	x 3	\$8.07
6	x 1 1/4	\$6.32
	x 1 1/2	\$6.32
	x 2	\$6.39
	x 2 1/2	\$7.42
	x 3	\$8.07
8	x 4	\$11.59
	x 2	\$7.42
	x 2 1/2	\$7.42
	x 3	\$8.07
	x 4	\$11.59

Clamp-T® Grooved Outlets Fig. 7046 Tee with Grooved Outlet

Nominal Pipe Size	Outlet	Standard "E" or "T" Gasket only Price Each
Run (Inches)	(Inches)	
2 1/2	x 1 1/4**	\$6.32
	x 1 1/2**	\$6.32
3	x 1 1/4	\$6.32
	x 1 1/2	\$6.32
4	x 1 1/4	\$6.32
	x 1 1/2	\$6.32
5	x 2	\$6.39
	x 2 1/2	\$7.42
	x 3	\$8.07
6	x 1 1/4	\$6.32
	x 1 1/2	\$6.32
	x 2	\$6.39
	x 2 1/2	\$7.42
8	x 3	\$8.07
	x 4	\$11.59
	x 2	\$7.42
	x 2 1/2	\$7.42
	x 3	\$8.07
	x 4	\$11.59

Roughneck™ Plain-End Products

Plain-End Coupling Roughneck™ Coupling Fig. 7005

Nominal Pipe Size (Inches)	Pipe Outside Diameter (Inches)	Aprx. Weight Each (Lbs.)	Coupling Complete w/"E" or "T" Gasket (Price Each)		Plated Bolt & Nut Size (Inches)
			Painted	Galv.	
2	2.375	5.3	\$74.12	\$91.95	5/8 x 3 1/4
2 1/2	2.875	5.7	\$74.12	\$91.95	5/8 x 3 1/4
3	3.500	8.7	\$109.64	\$136.65	3/4 x 4 1/2
4	4.500	12.8	\$126.82	\$160.94	3/4 x 4 1/2
5	5.563	17.3	\$181.12	\$229.42	7/8 x 5
6	6.625	23.2	\$221.12	\$286.73	1 x 6
8	8.625	37.2	\$407.38	\$499.26	7/8 x 5
10	10.750	48.2	\$509.90	\$650.81	1 x 6 1/2
12	12.750	60.0	\$640.62	\$839.50	1 x 6 1/2
14	14.000	88.0	\$908.48	\$1,121.53	1 x 6 1/2
16	16.000	95.0	\$1,244.01	\$1,510.12	1 x 6 1/2

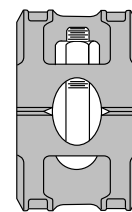
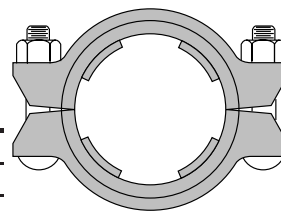

APPROVED
For listing/approval details contact your Gruvlok Representative.

*All bolts are oval-neck track head design to ASTM A-183, with heavy hex nuts to ASTM A-563, and are zinc plated to ASTM B-633. Weights are approximate and subject to change. Plain End Fittings are manufactured from fabricated steel. Other sizes available. Priced on application.

Rigidlite® 300 PSI Coupling Fig. 7400



For listing/approval details contact your Gruvlok Representative.

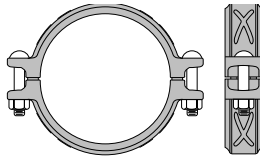

Nominal Pipe Size (Inches)	Pipe Outside Diameter (Inches)	Aprx. Weight Each (Lbs.)	Coupling Complete with "E" Gasket (Price Each) Painted	Plated Bolt & Nut Size (Inches)
2	2.375	1.6	\$22.52	3/8 x 2 1/4
2 1/2	2.875	1.9	\$25.54	3/8 x 2 1/4
3	3.500	2.1	\$29.36	3/8 x 2 3/4
4	4.500	3.1	\$41.54	3/8 x 2 3/4
5	5.563	4.6	\$60.99	1/2 x 3
6	6.625	5.5	\$74.56	1/2 x 3
8	8.625	8.4	\$117.05	1/2 x 3

All bolts are oval-neck track head design to ASTM A-183, with heavy hex nuts to ASTM A-563, and are zinc plated to ASTM B-633. Weights are approximate and subject to change. Two bolts per coupling.

Gruvlok Flange Fig. 7012



For listing/approval details contact your Gruvlok Representative.

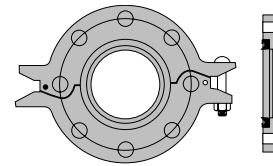

Nominal Pipe Size Hinged (Inches)	Pipe Outside Diameter (Inches)	Aprx. Weight Each (Lbs.)	Coupling Complete w/ "E" or "T" Gasket (Price Each) Painted
2*	2.375	4.6	\$117.20
2 1/2*	2.875	6.2	\$145.83
3*	3.500	6.6	\$157.34
4*	4.500	9.3	\$211.14
5*	5.563	10.2	\$245.06
6*	6.625	12.0	\$267.43
8*	8.625	15.6	\$301.99

The Gruvlok Flange bolt hole pattern conforms to Class 150 steel and Class 125 cast iron flanges utilizing standard flange bolts. Grade "E" Gasket recommended with copper piping. *Available with pn 10/16 bolt hole patterns. Flange Sealing Rings are recommended for use between wafer/lug type valves and Gruvlok Flanges. For applications with wafer valves a latch bolt is recommended on both sides of the flange. (request extra latch bolt) Use: 3/8 x 2 1/2 for 2"-6", 1/2 x 3 1/2 for 8"-12" sizes.

90° Elbows Fig. 7550



For listing details contact your Gruvlok Representative.

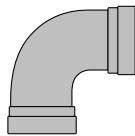

Nominal Pipe Size (Inches)	Aprx. Weight Each (Lbs.)	Price Each
2	0.9	\$33.98
2 1/2	1.5	\$37.05
3	2.4	\$52.48
4	5.5	\$122.77
5	9.3	\$350.87
6	17.6	\$561.06
8	29.4	\$1,054.38

8" fittings are copper coated stainless steel.

45° Elbows Fig. 7551



For listing details contact your Gruvlok Representative.

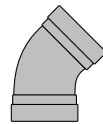

Nominal Pipe Size (Inches)	Aprx. Weight Each (Lbs.)	Price Each
2	0.6	\$33.98
2 1/2	1.1	\$37.05
3	1.6	\$52.48
4	3.5	\$122.77
5	6.1	\$350.87
6	11.7	\$561.06
8	19.4	\$1,054.38

8" fittings are copper coated stainless steel.

Tee Fig. 7560



For listing details contact your Gruvlok Representative.

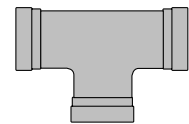

Nominal Pipe Size (Inches)	Aprx. Weight Each (Lbs.)	Price Each
2	1.7	\$56.89
2 1/2	2.5	\$60.55
3	3.5	\$90.93
4	7.3	\$200.80
5	7.9	\$565.97
6	13.4	\$699.99
8	41.7	\$1,250.98

8" fittings are copper coated stainless steel.

Grooved-End Couplings

Fittings

Valves and Accessories

Spare Parts

Plain-End

Copper Method

Tools

Copper Reducing Tee Fig. 7561A



For listing details contact your Gruvlok Representative.

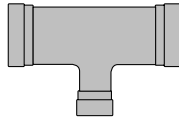

Nominal Pipe Size (Inches)		Aprx. Weight Each (Lbs)	Price Each
2 1/2 x 2 1/2	x 2	1.8	\$91.45
3 x 3	x 2	2.7	\$117.64
	x 2 1/2	2.1	\$155.36
4 x 4	x 2	4.8	\$264.93
	x 2 1/2	4.9	\$264.93
	x 3	5.1	\$264.93
5 x 5	x 3	7.5	\$811.67
	x 4	7.8	\$811.67
6 x 6	x 2 1/2	11.5	\$991.55
	x 3	11.7	\$991.55
	x 4	12.1	\$991.55
8 x 8	x 2 1/2	18.0	POA
	x 3	18.2	POA
	x 4	18.4	POA
	x 5	18.8	POA
	x 6	19.0	POA

NOTE: Use Fig. 7400 Rigidlite coupling for the Gruvlok Advanced Copper System.

Gruvlok copper fittings are WROT or fabricated copper. Contact Anvil for material specification.

* Fittings are copper electroplated 316 SS.

Additional sizes available, Contact Anvil for details.

Copper Reducing Tee Fig. 7564A Gr x Gr x Cup



For listing details contact your Gruvlok Representative.

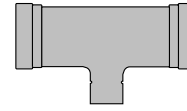

Nominal Pipe Size (Inches)		Aprx. Weight Each (Lbs)	Price Each
2 x 2	x 3/4	1.0	\$73.16
	x 1	1.0	\$73.16
	x 1 1/4	1.1	\$73.16
	x 1 1/2	1.1	\$73.16
2 1/2 x 2 1/2	x 3/4	1.6	\$94.02
	x 1	1.7	\$91.51
	x 1 1/4	1.7	\$91.51
	x 1 1/2	1.7	\$91.51
	x 2	1.8	\$91.51
3 x 3	x 1	2.5	\$170.26
	x 1 1/4	2.5	\$170.26
	x 1 1/2	2.6	\$170.26
4 x 4	x 2	2.7	\$170.26
	x 3/4	4.5	\$201.32
	x 1	4.6	\$264.93
	x 1 1/4	4.7	\$264.93
4 x 4	x 1 1/2	4.7	\$264.93
	x 2	4.8	\$264.93

NOTE: Use Fig. 7400 Rigidlite coupling for the Gruvlok Advanced Copper System.

Additional sizes available, Contact Anvil for details.

Concentric Reducers Fig. 7572 (Gr x Gr)



For listing details contact your Gruvlok Representative.

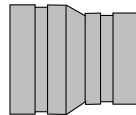

Nominal Size x Branch (Inches)	Outlet (Inches)	End to End (Inches)	Aprx. Weight Each (Lbs)	Price Each
2 1/2	x 2	3.13	0.6	\$49.62
3	x 2	3.38	1.0	\$49.62
	x 2 1/2	3.13	0.9	\$49.62
4	x 2	3.88	2.2	\$103.25
	x 2 1/2	3.63	2.0	\$103.25
	x 3	3.38	2.0	\$103.25
5	x 3	3.88	2.8	\$293.18
	x 4	3.38	3.3	\$293.18
6	x 3	4.38	4.9	\$317.56
	x 4	3.88	4.8	\$317.56
	x 5	3.38	5.2	\$317.56
8	x 6	5.00	10.0	\$558.63

Cap Fig. 7574



For listing details contact your Gruvlok Representative.

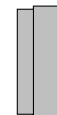

Nominal Pipe Size (Inches)	Aprx. Weight Each (Lbs.)	Price Each
2	1.2	\$23.34
2 1/2	1.4	\$34.71
3	1.4	\$43.89
4	2.4	\$66.35
5	3.5	\$71.40
6	4.2	\$516.83
8	-	POA

8" fittings are copper coated stainless steel.

**Reducing Adapters Fig. 7575
(Gr. x Cup)**



For listing details contact your Gruvlok Representative.

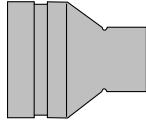

Nominal Size x Branch (Inches)	Outlet (Inches)	End to End (Inches)	Cup (Inches)	Aprx. Weight Each (Lbs)	Price Each
2	x 1	2.70	0.91	0.4	\$41.25
	x 1¼	3.00	0.97	0.4	\$41.25
	x 1½	2.94	1.09	0.4	\$41.25
2½	x 1	3.25	0.91	0.6	\$50.49
	x 1¼	3.52	0.97	0.6	\$50.49
	x 1½	3.45	1.09	0.7	\$50.49
	x 2	3.30	1.34	0.7	\$50.49
3	x 1½	3.68	1.09	1.1	\$62.90
	x 2	4.10	1.34	1.0	\$62.90
4	x 2	4.75	1.34	2.2	\$118.22

**Transition Fitting Fig. 7582
(Cup x Gr.)**



For listing details contact your Gruvlok Representative.

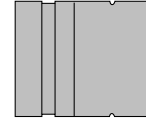

Nominal Pipe Size (Inches)	Aprx. Weight Each (Lbs.)	Price Each
2	0.4	\$14.17
2½	0.6	\$30.38
3	1.0	\$40.80
4	2.0	\$91.51
5	3.3	\$219.36
6	5.3	\$272.26

DI-LOK® DI-Electric Nipple Fig. 7088 (Gr. x Th.)

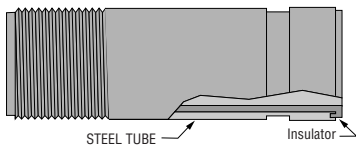

Pipe Size (Inches)	Nominal Length (Inches)	Aprx. Weight Each (Lbs.)	Price Each
1¼	4	0.6	\$61.14
1½	4	0.8	\$78.30
2	4	1.0	\$47.85
2½	6	1.6	\$65.54
3	6	2.0	\$118.89
4	6	4.5	\$159.77

DI-LOK® DI-Electric Nipple Fig. 7089 (Gr. x Gr.)

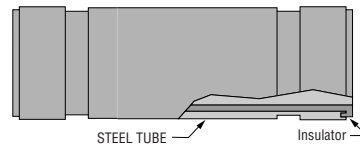

Pipe Size (Inches)	Nominal Length (Inches)	Aprx. Weight Each (Lbs.)	Price Each
2	4	1.0	\$47.85
2½	6	1.6	\$65.54
3	6	2.0	\$118.89
4	6	4.5	\$159.77
5	6	7.3	\$251.87
6	6	9.5	\$315.07

Grooved-End Couplings

Fittings

Valves and Accessories

Spare Parts

Plain-End

Copper Method

Tools

DI-LOK® DI-Electric Nipple Fig. 7090 (Th. x Th.)



Pipe Size (Inches)	Nominal Length (Inches)	Aprx. Weight Each (Lbs.)	Price Each
1/2	3	0.2	\$22.76
3/4	3	0.2	\$15.55
1	4	0.4	\$24.00
1 1/4	4	0.6	\$34.87
1 1/2	4	0.8	\$42.13
2	4	1.0	\$100.46
2 1/2	6	1.6	\$137.38
3	6	2.0	\$176.13

Bronze Grooved End Ball Valve, Fig. 7500B



Fig. 7500B

Fig. 7500B with
Stem Extension

Nominal Size (Inches)	Aprx. Weight Each (Lbs.)	Price Each
1 1/2	3.5	\$273.96
2	4.5	\$380.52
2 1/2	8.0	\$529.12
3	13.0	\$596.20
4	22.0	\$705.11

Stem Extension Kits

1 1/2	0.3	\$11.23
2	0.4	\$13.95
2 1/2 - 4	0.5	\$17.40

Model 1007/3007 Roll Groover

Item	Shipping Weight	Price	Includes
1007 Roll Groover	550 lbs.	\$14,768.79	Motorized Roll Groover with 2" - 12" Steel Rolls Closed Wood Crate
3007 Roll Groover	330 lbs.	\$10,080.79	For Ridgid® 300 Power Drive Support Legs 2" - 12" Steel Rolls Closed Wood Crate
Options:			
Copper 2" - 6"		\$2,520.16	2" - 6" Copper Rolls M&L Guide Roll Assembly Universal Diameter Gage
Copper "K" Plate		\$426.39	
Copper "DWV" Plate		\$426.39	
Universal Diameter Gage		\$722.66	
14" - 16" Rolls		\$1,741.67	14" - 16" Steel Rolls Guide Roll Assembly

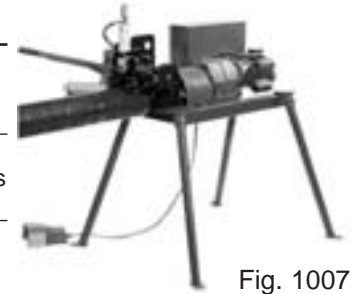

Fig. 1007



Fig. 3007

Model 3006 (Steel Roll Groover) – for Ridgid® 300 Power Drive

Item	Shipping Weight	Price	Includes
3006 Roll Groover	170 lbs.	\$6,368.30	2" - 12" Steel Rolls Hydraulic Pressure Gage Support Legs Closed Wood Crate (1 set) Depth Gages – 1" - 12"
Copper 2" - 6"		\$2,173.39	2" - 6" Copper Rolls Guide Roll Assembly for M&L, K & DWV Pipe Universal Diameter Gage
Universal Diameter Gage		\$722.66	

Model 3006 (Copper Roll Groover) – for Ridgid® 300 Power Drive

Item	Shipping Weight	Price	Includes
3006 Roll Copper	170 lbs.	\$6,583.32	2" - 12" Copper Rolls Hydraulic Pressure Gage Support Legs Guide Roll Assembly for M&L, K & DWV Pipe Universal Diameter Gage Closed Wood Crate
2" - 12" Steel Rolls		\$1,958.38	Guide Roll Assembly for M&L, K & DWV Pipe
Universal Diameter Gage		\$722.66	

For information regarding additional custom grooving tools, contact Anvil.

Grooved-End Couplings

Fittings

Valves and Accessories

Spare Parts

Plain-End

Copper Method

Tools

Fig. 7240 Expansion Joints

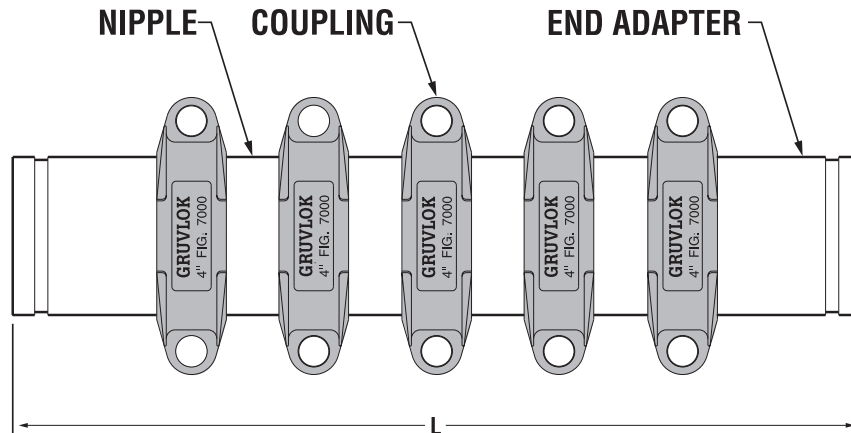

PERFORMANCE DATA (Inches)									
Pipe Size	Nominal Pipe O.D.	Coupling Figure	X	Y	Compressed Length L	Expanded Length L	Coupling Movement Capability	Number of Couplings	Total Movement Capability
2	2.375	7000	3 ¹ / ₂	5 ¹ / ₂	30	31 ¹ / ₄	1 ¹ / ₈	10	1 ¹ / ₄
2 ¹ / ₂	2.875	7000	4	5 ³ / ₄	30	31 ¹ / ₄	1 ¹ / ₈	10	1 ¹ / ₄
3	3.500	7000	4 ⁵ / ₈	6 ³ / ₄	30	31 ¹ / ₄	1 ¹ / ₈	10	1 ¹ / ₄
4	4.500	7000	5 ⁷ / ₈	8 ¹ / ₈	17 ¹ / ₂	18 ³ / ₄	1 ¹ / ₄	5	1 ¹ / ₄
5	5.562	7000	7	9 ⁵ / ₈	19	20 ¹ / ₄	1 ¹ / ₄	5	1 ¹ / ₄
6	6.625	7000	8	11	19	20 ¹ / ₄	1 ¹ / ₄	5	1 ¹ / ₄
8	8.625	7000	10 ³ / ₈	13 ¹ / ₄	22 ¹ / ₂	23 ³ / ₄	1 ¹ / ₄	5	1 ¹ / ₄
10	10.750	7001	12 ⁷ / ₈	17 ¹ / ₂	23 ¹ / ₂	24 ³ / ₄	1 ¹ / ₄	5	1 ¹ / ₄
12	12.750	7001	15	19 ¹ / ₂	23 ¹ / ₂	24 ³ / ₄	1 ¹ / ₄	5	1 ¹ / ₄

When requesting a quotation or placing an order, please complete the following form and fax a copy to 717-684-2131 to the attention of Customer Service:

- 1) Size and material of pipe to which the expansion joint will be connected: _____
- 2) Factory to preset the Expansion Joint to: _____ Full Expansion _____ Full Contraction _____ Intermediate
- 3) Total overall movement while in service: _____ inches
- 4) Pipe material for Expansion Joint (standard is Sch. 40 steel): _____
- 5) Finish on pipe (standard is black): _____
- 6) Finish on couplings (standard is painted): _____
- 7) Gasket material (standard is Grade E EPDM): _____
- 8) Connecting pipe ends if different than standard roll or cut groove: _____
- 9) Are there any silicone restrictions for the application? _____ Yes _____ No

Fig. 400 G	Silent Check Valve	24	Fig. 7400	Rigidlite® 300 PSI Coupling	7
Fig. 7000	Lightweight Flexible Coupling	6	Fig. 7400	Rigidlite® 300 PSI Coupling (Copper)	32
Fig. 7001	Standard Coupling	5	Fig. 7401	Rigidlok™ Rigid Coupling	7
Fig. 7003	Hingelok Coupling	6	Fig. 7500	Gruvlok Ball Valves	22
Fig. 7004 EG	End Guard Coupling	9	Fig. 7500B	Bronze Grooved End Ball Valves	23
Fig. 7004 HPR	HPR Coupling	9	Fig. 7500B	Bronze Grooved End Ball Valves (Copper)	35
Fig. 7005	Plain-End Coupling	31	Fig. 7550	90° Elbows	32
Fig. 7010	Reducing Coupling	7	Fig. 7551	45° Elbows	32
Fig. 7011	Standard Coupling	5	Fig. 7560	Tee	32
Fig. 7012	Gruvlok Flange	10	Fig. 7561A	Copper Reducing Tee	33
Fig. 7012	Gruvlok Flange (Copper)	32	Fig. 7564A	Copper Reducing Tee (Gr x Gr x Cup)	33
Fig. 7013	Gruvlok 300# Flange	10	Fig. 7572	Concentric Reducers (Gr x Gr)	33
Fig. 7045	Clamp-T® Female Threaded Outlet	27	Fig. 7574	Cap	33
Fig. 7046	Clamp-T® Grooved Outlet	27	Fig. 7575	Reducing Adapters (Gr x Cup)	34
Fig. 7047	Clamp-T® Cross	28	Fig. 768 G	Grooved-End “WYE” Strainer	26
Fig. 7048	Clamp-T® Cross	28	Fig. 7582	Transition Fitting (Cup x Gr)	34
Fig. 7049	Clamp-T® Cross	28	Fig. 7800	End Check Valve	24
Fig. 7050	90° Elbows	11	Fig. 8000GR	Gruvlok Butterfly Valves	22
Fig. 7050 LR	90° Long Radius Elbows (1½”D)	18	Fig. FTV-A	Angle Body Valve	26
Fig. 7050RF	Reducing Base Support Elbows (G x F)	18	Fig. FTV-S	Straight Body Valve	26
Fig. 7051	45° Elbows	11	Fig. GBV-A	Grooved End Angle Circuit Balancing Valves	24
Fig. 7051 LR	45° Long Radius Elbows (1½”D)	18	Fig. GBV-G	Grooved End Straight Balancing Valves	24
Fig. 7052	22½° Elbows	11	Fig. GBV-S	Sweat Four Turn Balancing Valves	23
Fig. 7053	11¼° Elbow	11	Fig. GBV-T	Threaded Four Turn Circuit Balancing Valves	23
Fig. 7060	Tees	12	Fig. i7042F	Outlet Couplings	8
Fig. 7061	Reducing Tee	13	Fig. i7042G	Outlet Couplings	8
Fig. 7063	Tees With Threaded Branch	12	Fig. i7042M	Outlet Couplings	8
Fig. 7064	Reducing Tee With Threaded Branch	14	Gaskets, Special		3
Fig. 7066	Tee WYE	19	Gaskets, Standard		3
Fig. 7068	Steel Cross	20	GAV-15	Gruvlok Air Vent	26
Fig. 7069	Lateral	19	GAV-30	Gruvlok Air Vent	26
Fig. 7070	Reducing Lateral	20	Lubricants		3
Fig. 7071	True Y	20	Model 1007	MRoll Groover	36
Fig. 7072	Concentric Reducer	15	Model 3006	For Ridgid® 300 Power Drive	36
Fig. 7073	Eccentric Reducer	17	Model 3006C	Copper Roll Groover –	
Fig. 7074	Cap	16		For Ridgid® 300 Power Drive	36
Fig. 7075	Bullhead Plug	19	Model 3007	Model 1007/3007 Roll Groover	36
Fig. 7076	Reducer Threaded Small End	16	Series 7600	Grooved End Butterfly Valve	23
Fig. 7084	Flange Nipples (150 lbs)	29	Series 7700	Grooved End Butterfly Valve	21
Fig. 7085	Flange Nipples (300 lbs)	29	SF21-FF	SF21-FF Flange x Flange Connectors	25
Fig. 7086	Hose Nipple	16	SF21-GF	SF21-GF Grooved x Flange Connectors	25
Fig. 7087	Female Thread Adapter	18	SF21-GG	SF21-GG Grooved x Grooved Connectors	25
Fig. 7088	DI-LOK® DI-Electric Nipple (Gr. x MPT)	34	Spare Parts		
Fig. 7089	DI-LOK® DI-Electric Nipple (Gr. x Gr.)	34	Fig. 7004 EG , Standard Gaskets		30
Fig. 7090	DI-LOK® DI-Electric Nipple (MPT x MPT)	35	Fig. 7005 & 7305, Standard Gaskets		30
Fig. 7097	Eccentric Reducer	17	Fig. 7010 Gasket		30
Fig. 7240	Expansion Joint	37	Fig. 7012 & 7013, Flange Parts		29
Fig. 7250	Suction Diffuser	25	Fig. 7012 & 7013, Flange Gaskets		30
Fig. 7260	Grooved End Strainer	26	Fig. 7045 (Gasket Only), Clamp-T® Female Threaded Outlet		31
Fig. 7305	HDPE Coupling	9	Fig. 7046 (Gasket Only), Clamp-T® Grooved Outlet		31
Fig. 7307	HDPE Transition Coupling	9	Plated Trackhead Bolts and Nuts		30
Fig. 7312	Flange Adapter for HDPE Pipe	9			

Victaulic®Gruvlok®	Product
07.....7401	Rigidlok Coupling
08.....7400 SS	Rigidlite Stainless Steel Coupling
10.....7050	90° Elbows
10-3D.....7050-3D	3D Long Radius 90° Elbows
10-5D.....7050-5D	5D Long Radius 90° Elbows
10-6D.....7050-6D	6D Long Radius 90° Elbows
10-P.....7050P	90° Elbow
R-10F.....7050RF	Reducing Base Support Elbows Grooved x Flanged (G x F)
11.....7051	45° Elbows
11-3D.....7051-3D	3D Long Radius 45° Elbows
11-5D.....7051-5D	5D Long Radius 45° Elbows
11-6D.....7051-6D	6D Long Radius 45° Elbows
11-P.....7051P	45° Elbow
12.....7052	22½° Elbows
12-3D.....7052-3D	3D Long Radius 22½° Elbows
12-5D.....7052-5D	5D Long Radius 22½° Elbows
12-6D.....7052-6D	6D Long Radius 22½° Elbows
13.....7053	11¼° Elbow
13-3D.....7053-3D	3D Long Radius 11¼° Elbows
13-5D.....7053-5D	5D Long Radius 11¼° Elbows
13-6D.....7053-6D	6D Long Radius 11¼° Elbows
14-3D.....7057-3D	3D Long Radius 60° Elbows
14-5D.....7057-5D	5D Long Radius 60° Elbows
14-6D.....7057-6D	6D Long Radius 60° Elbows
15-3D.....7058-3D	3D Long Radius 30° Elbows
15-5D.....7058-5D	5D Long Radius 30° Elbows
15-6D.....7058-6D	6D Long Radius 30° Elbows
18.....7055	90° Adapter Elbows
19.....7056	45° Adapter Elbows
20.....7060	Tees
20-P.....7060P	Te
20SSLT,	
20-SSSW.....7060-SS16	Type 316 Stainless Steel Tees
21.....7062	Bullhead Tee
22 ES.....7022	Header Tee
35.....7068	Cross Tee
25.....7061	Reducing Tee
25-P.....7061P	Fabricated steel Reducing Tees
25-SS.....7061-SS16	Type 316 Stainless Steel Reducing Tee
27.....7065	Standpipe Tee
29M.....7063	Tees With Threaded Branch*
29T.....7064	Reducing Tee With Threaded Branch
30.....7069	Lateral
30-P.....7069P	Lateral
30R.....7070	Reducing Lateral
32.....7066	Tee WYE
32R.....7067	Reducing Tee WYE
33.....7071	90° True WYE
33-P.....7071P	True WYE
35.....7068EG	Cross
35-P.....7068P	Cross
40.....7081F	Adapter Nipple – (Gr. x MPT)
40.....7081	Seamless Adaptor Nipples (Gr. x MPT)
41.....7083	Flanged Adapter (125 Lb)
42.....7082F	Adapter Nipple – (Gr. x Bev)
42.....7082	Seamless Adaptor Nipples (Gr. x Bev)
43.....7080F	Adapter Nipple – (Gr. x Gr.)
43.....7080	Seamless Adaptor Nipples (Gr. x Gr.)
45.....7084	Flanged Adapter (150 Lb)
46.....7085	Flanged Adapter (300 Lb)
47.....7088	DI–Electric Nipple (Gr. x Th.)
47.....7089	DI–Electric Nipple (Gr. x Gr.)
47.....7090	DI–Electric Nipple (Th. x Th.)

Victaulic®Gruvlok®	Product
48.....7086	Hose Nipple
50.....7072	Concentric Reducer
50-SSLT.....7072-SS16	Concentric Reducers
51.....7073	Eccentric Reducer
51-SSLT.....7073-SS16	Eccentric Reducers
52.....7076	Reducer Threaded Small End
53.....7077	Steel Swaged Nipple
53-P.....7077P	Steel Plain End Swaged Nipple
54.....7078	Steel Swaged Nipple
55.....7079	Steel Swaged Nipple
60.....7074	Cap
60-SS.....7074-SS16	Type 316 Stainless Steel Cap
61.....7075	Bullhead Plug
61-P.....7075P	Bull Plug
62 ES.....7050 EG	Extra Heavy “EG” End Guard Fittings 90° Elbow
63 ES.....7051 EG	Extra Heavy “EG” End Guard Fittings 45° Elbow
64 ES.....7060 EG	Extra Heavy “EG” End Guard Fittings Tee
72.....7042	Outlet Coupling
75.....7000	Lightweight Coupling
75.....7400	Rigidlite Coupling
77.....7001	Standard Coupling
78.....7003	Hingelok Coupling
80.....7087	Female Thread Adapter
99.....7005	Roughneck Coupling
994.....7312	HDPE Flange Adapter
995.....7305	Gruvlok HDPE Coupling
997.....7307	Transition Coupling
100.....7050 LR	90° Long Radius Elbows
100-SS.....7050-SS16	Type 316 Stainless Steel 90° Elbow
100-SSLT.....7050-SS16	Type 316 Stainless Steel Long Radius Long Tangent 90° Elbow
110.....7051 LR	45° Long Radius Elbows
110-SS.....7051-SS16	Type 316 Stainless Steel 45° Elbow
110-SSLT.....7051-SS16	Type 316 Stainless Steel Long Radius Long Tangent 45° Elbow
300.....7700	Gruvlok Butterfly Valves
610.....7550	90° Elbows Copper
611.....7551	45° Elbows Copper
620.....7560	Copper Tee
625.....7561 A	Copper Reducing Tee (Gr. x Gr. x Gr.)
626.....7564 A	Copper Reducing Tee (Gr. x Gr. x Cup)
650.....7572	Concentric Reducers (Gr. x Gr.)
652.....7575	Reducing Adapters (Gr. x Cup)
660.....7574	Copper Cap
709.....8000GR	Gruvlok Butterfly Valves
711, 715, 716.....7800	Gruvlok End Check Valve
721.....7500	Gruvlok Ball Valves
709.....7600	Gruvlok Grooved End Butterfly Valve
730.....7260	Grooved End Strainer
731.....7250	Suction Diffuser
732.....7582	Copper Transition Fitting
741.....7012	Gruvlok Flange
743.....7013	Gruvlok 300# Flange
750.....7010	Reducing Coupling-
920 Cross.....7047	Clamp-T® Cross (Thd x Thd)
920 Cross.....7048	Clamp-T® Cross (Gr. x Gr.)
920 Cross.....7049	Clamp-T® Cross (Gr. x Thd)
921.....7046	Clamp-T® Grooved Outlet
HP-70.....7004 HPR	HPR Coupling (with Standard Gasket)
HP-70ES.....7004 EG	End Guard Coupling (w End Guard Gasket)
VE260.....1007/3007	Gruvlok Roll Groover
VE226.....3006	Gruvlok Steel Roll Groover for Rigid® 300 Power Drive
VE226.....3006 C	Gruvlok Copper Roll Groover for Rigid® 300 Power Drive



Corporate Offices
110 Corporate Drive, Suite 10 • P.O. Box 3180
Portsmouth, NH 03802-3180
Tel: 603-422-8000 • Fax: 603-422-8033
E-mail address — Webmaster@anvilintl.com
www.anvilintl.com

For Sales and Service Information Contact the Regional Service Center Nearest You or Visit Our Website at www.anvilintl.com

U.S. Regional Service Centers

NORTHEAST REGION

Servicing: Connecticut, Delaware, Maine, Maryland, Massachusetts, New Hampshire, New Jersey, New York, East Pennsylvania, Rhode Island, Vermont, Virginia

2530 Pearl Buck Road

Bristol, PA 19007

Tel: 215-788-4056 • Fax: 215-788-4475

Toll Free: 1-800-451-2935

WESTERN REGION

Servicing: Alaska, Arizona, California, Hawaii, Idaho, Montana, Nevada, Oregon, Utah, Washington

1385 Greg Street

Sparks, NV 89431

Tel: 775-331-7029 • Fax: 775-331-5075

Toll Free: 1-800-572-0051

MIDWEST REGION

Servicing: Illinois, Indiana, Iowa, Kansas, Kentucky, Michigan, Minnesota, Missouri, Nebraska, North and South Dakota, Ohio, West Pennsylvania, West Virginia, Wisconsin

750 Central Avenue

University Park, IL 60466

Tel: 708-534-1414 • Fax: 708-534-5441

Toll Free: 1-800-301-2701

EUROPE & MIDDLE EAST REGION

Rick van Meesen, *Business Director*
the Netherlands

Tel: +31 53 5725570

Fax: +31 53 5725579

U.S. Customer Service Tel: +1 708 534 1414

LATIN AMERICA, PUERTO RICO & MEXICO

U.S. Customer Service

Tel: 708-534-1414 • Fax: 708-534-5441

SOUTHERN REGION

Servicing: Alabama, Arkansas, Colorado, Florida, Georgia, Louisiana, Mississippi, New Mexico, North and South Carolina, Oklahoma, Tennessee, Texas, Wyoming

1313 Avenue R

Grand Prairie, TX 75050

Tel: 972-343-9206 • Fax: 972-641-8946

Toll Free: 1-800-451-4414

ANVILStar™

Fire Products Division of Anvil International

ANVILSTAR CUSTOMER SERVICE CENTER

Tel: 708-534-1414 • Fax: 708-534-5441

Toll Free: 1-800-301-2701